

SUN-Control Analytik®

Products for gas analytic technology

Product overview Version V1-2024-OP
Valid from January 1, 2024 to December 31, 2024
(This issue replaces all the previous versions)

Made in Germany



Hydrogen tested
Ready for the future energy



SIL ✓
prepared

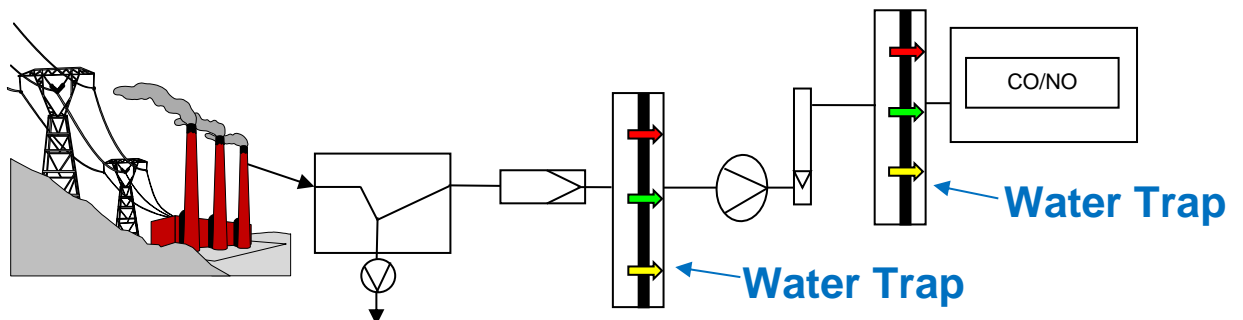

Product-Overview

Water-Traps:



Water-Trap model WT 20.5

The classic model with diaphragms for stopping water, acids, alkaline solutions, aerosols and extra fine dust

Page: 7-9



Water-Acid-Trap model WT 20.48 KOBE and WT 20.48 KOBU

For high flow rates, with condensate output.

Stops water, acids, alkaline solutions, aerosols and extra fine dust

Page: 10-12



Water-Trap model WT 20.5 A

Suction filter with integrated Water-Trap.

Stops water, acids, alkaline solutions, aerosols, insects and extra fine dust

Page: 13

Water-Oil-Traps:



Water-Oil-Trap model WT 20.83 PVDF XL

Water-Oil-Trap model WT 20.83 PVDF EL XL

Water-Oil-Trap model WT 20.83 PFA XL

For process analysis. All components made of high performance plastic. With integrated XL filter for particle and permanent liquid separation.

Stops water, acids, alkalis, aerosols, liquid hydrocarbons (oils, gasolines) and extra fine dust by Dual-Membrane-System®

Page: 14-17



Water-Oil-Trap model WT 20.83 E XL

For process analysis. All components made of stainless steel.

With integrated XL filter for particle and permanent liquid separation.

Stops water, acids, alkalis, aerosols, liquid hydrocarbons (oils, gasolines) and extra fine dust by Dual-Membrane-System®

Page: 18-21



Water-Oil-Trap model WT 20.83 E XL HD. Up to 220 bar
 For process analysis. All components made of stainless steel.
 With integrated XL filter for particle and permanent liquid separation.
 Stops water, acids, alkalis, aerosols, liquid hydrocarbons (oils, gasolines)
 and extra fine dust by Dual-Membrane-System[®]

Page: 22



Water-Oil-Trap model WT 20.82 E
 For process analysis. All components made of stainless steel.
 Stops water, acids, alkalis, aerosols, liquid hydrocarbons (oils, gasolines)
 and extra fine dust by Dual-Membrane-System[®]

Page: 23-25



Water-Oil-Trap model WT 30.5 E
 For process analysis. All components made of stainless steel.
 With a low gas volume of just 2,0 ml, for Micro-GC-Technology
 Stops water, acids, alkalis, aerosols, liquid hydrocarbons (oils, gasolines)
 and extra fine dust by Dual-Membrane-System[®]

Page: 26-28

Filter for particle and liquid deposition:



Filter model PC 1410 E
 Particle and coalescence filter for
 deposition of liquids and particles

Page: 29-33



Filter model PC 1410 E XL
 Particle and coalescence filter for
 deposition of liquids and particles

Page: 34-37



Filter model PC 1410 PVDF
 Particle and coalescence filter for
 deposition of liquids and particles

Page: 38-40



Acid filter model SF 20.13
Acid filter for deposition of acid droplets
and aerosols

Page: 41-42



Particle filter model PF 2017
Filter for the separation of dust particles

Page: 43



Absorber model ABS 20.03
Absorber for removal of aggressive
components such as SO₃, HF, HCL, H₂S

Page: 44-45



Gas sampling filter model model GEF 26
Process gas extraction for gas analyzers
Inlying dust filter

Page: 46-48

Gas cooling / Process-Analytic-Cooler / Condensate Pre Separator:



Condensate-Pre-Separator model KVE
For continuous separation
of gases and liquid mixtures

Page: 49-50



Cooling coil model SPENIV
For temperature reduction/levelling
of process gases, with free convection

Page: 51-52



Process-Analytic-Cooler model GT5.65
Robust Transmitter design protection class **IP 65**

SIL ✓
prepared

Process-Analytic-Cooler model GT5.SE
Low budget unit for analysis cabinet assembly **IP 20**

Page: 53-56



Process-Analytic-Cooler model GT5.EX 
Gas-Explosion proof design for zone 1
Dust-Explosion proof design for zone 21
Robust Transmitter design protection class **IP 66**

SIL ✓
prepared

Page: 57-60

Information / Terms of business:

General information / Gas flow diagrams / Quality management

Page: 62-72

Installation examples of SUN-Control-Analytik products

Page: 73-77

Schematic illustration:

The Water-Trap with the SUN-C membrane technology[®] serves as a "police filter" for the protection of gas analyzers

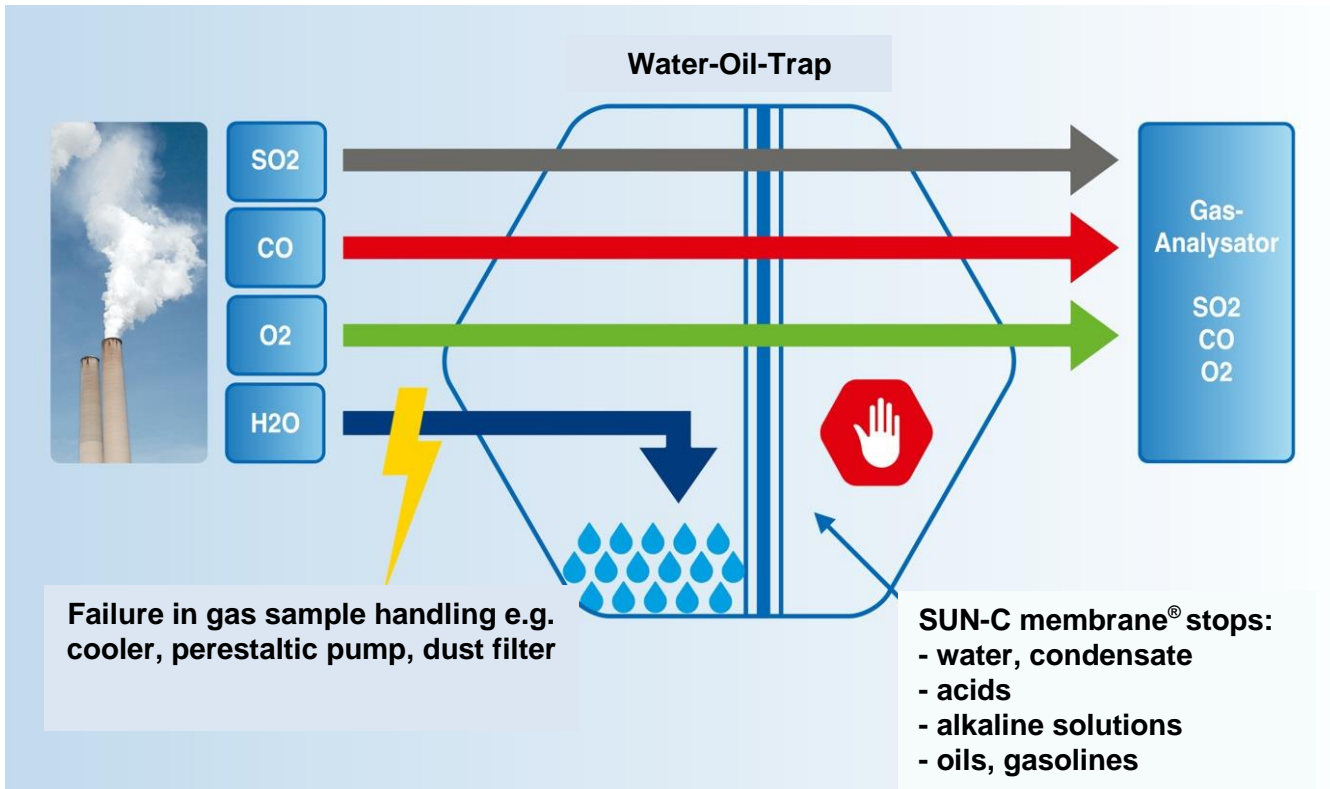

Elementary important protective function: The membrane of the Water-Trap protects the gas analyzer reliably and permanently from dust and condensates

Unrestricted sample gas flow: Gases pass unhindered through the semipermeable **SUN-C Membrane[®]** (fluoropolymer) with additional **fine dust filter of 0.1 µm**

Easy installation: Installation in the existing tubing upstream of the gas analyzer

Extreme economy: Low investment costs for preventive protection against analyzer failure

Quality assurance: through function control



Water-Trap with extra fine particle filter model WT 20.5

- Secure protection of the gas analyser from condensate and extra fine dust
- Low costs for reliable safety
- Made in Germany  
- Certificates: ATEX 2014/34/EU, leakage tested

Functional description:

The Water-Trap is installed directly in front of the gas analyser in the piping. If the upstream gas processing (cooler, peristaltic pump, dust filter and the like) fails, the Water-Trap uses its semi-permeable **SUN-C membrane**[®] to protect the gas analyser. The membrane separates gases from condensate and extra fine dust. If it is fully filled, the gas flow will be interrupted. An alarm is indicated via the upstream flowmeter with monitoring (refer to sample applications). The Water-Trap is also known as a "Police filter".

Additional information from experience:

If the filter element, of the dust filter located in the gas processing is changed, particles are consistently dissolved and directed into the analyser. The downstream Water-Trap prevents this contamination as well with its membrane pore size of 0.1 µm.

Technical specifications:

Scope of delivery:	Water-Trap, connection adapters (option), 2x assembly bracket for wall mounting (option)
Water pressure membrane:	0 - 2 bar
Operating pressure for gas:	0 - 2 bar
Gas flow:	0 - 400 l air/h
Pressure drop at 100 l air/h:	approx. 10 mbar
Pressure drop at 400 l air/h:	approx. 40 mbar
Diaphragm pore size:	< 0.1 µm
Operating temperature:	0°C - +90°C
Effective filter area:	25 cm ²
Housing volume:	5 ml
Materials used:	PTFE, PP, assembly bracket made of stainless steel 1.4301 (option)
Dimensions:	Diameter 70 mm, length 120 mm
Gas connections:	on both sides 1/8" NPT outside thread or on both sides 6 mm pipe nozzle or on both sides 6-12 mm stepped hose barb
Assembly:	Mounting in the existing piping
Gas explosion proof ATEX:	 II 2G Ex h IIB Gb -10°C ≤ Ta ≤ +90°C attestation EPS 19 ATEX 2 177 U
Helium leakage test:	2 x 10 ⁻⁸ mbar l/s
Language operating instructions:	German and English (included in the scope of delivery) Spanish, Italian, French, Russian upon request
Certificates/attestations:	certificate of conformity ATEX 2014/34/EU, Helium leakage test attestation

For operation in potentially explosive ambience:

The products can be used in explosive ambience of Zone 1 and Zone 2.

Allowed the explosion classes IIA and IIB.

The products have no self-heating during intended operation and can be used in dependency of the maximum permissible media temperature for gases of the temperature class T6.

Helium leakage test:

The product line has been subjected to a helium leak test. Single attestation on request

Suitable for the following applications:

- Emission measurements with fossil fuels
- Renewable energy (Hydrogen technology)
- Biogases
- Ambient air monitoring
- Process measurement
- Heat treatments
- Cement, glass, steel, paper industries
- Combustion engines

Not suitable for the following applications:

Condensate with aromatic hydrocarbons, e.g. oils and fuels in refinery process gases.

The models 20.82 E and the model 20.83 E XL with their oil-block membrane and coalescence filters have been designed for this.

Protection from dust:

The Water-Trap shows severe contamination of dust. The membrane with its pore size of 0.1 µm retains even the finest dusts.

Gas inlet with particle contamination



Gas outlet without dust particle the analyzer is protected. The membrane is a perfect fine particle filter

Connection variation:

WT 20.5 R with 6 mm pipe nozzle



Connection adapter VE6R64 for 6 mm pipe connection on 6/4 mm hose
 Item number: VE6R64

WT 20.5 N with 1/8" NPT thread



Connection adapter VE18N64 for 1/8" NPT thread on 6/4 mm hose
 Item number: VE18N64

WT 20.5 S with stepped hose barb



Option: 2 pieces assembly brackets for wall mountig

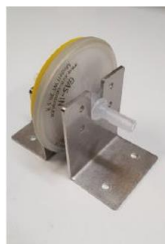

Assembly brackets for wall mountig (Option)
 Article: MONWIWAMO205

Article numbers:

protection of utility patents DE 20 2016 100 476

Article	Article number
Water-Trap WT 20.5 R, connections on both sides 6 mm nozzle	WT205R
1 pair (2 units) connection adapter with 6 mm pipe connection for screwed hose connection 6/4 mm	VE6R64
Water-Trap WT 20.5 N, connections on both sides 1/8" NPT outside thread	WT205N
1 pair (2 units) connection adapter with 1/8" NPT threaded connection for screwed hose connection 6/4 mm	VE18N64
Water-Trap WT 20.5 S, connections on both sides 6.1 mm-12.7 mm stepped hose barb	WT205S
2 pieces assembly brackets for wall mountig for all models of the WT 20.5	MONWIWAMO205

Sample application 1: Flue gas analysis

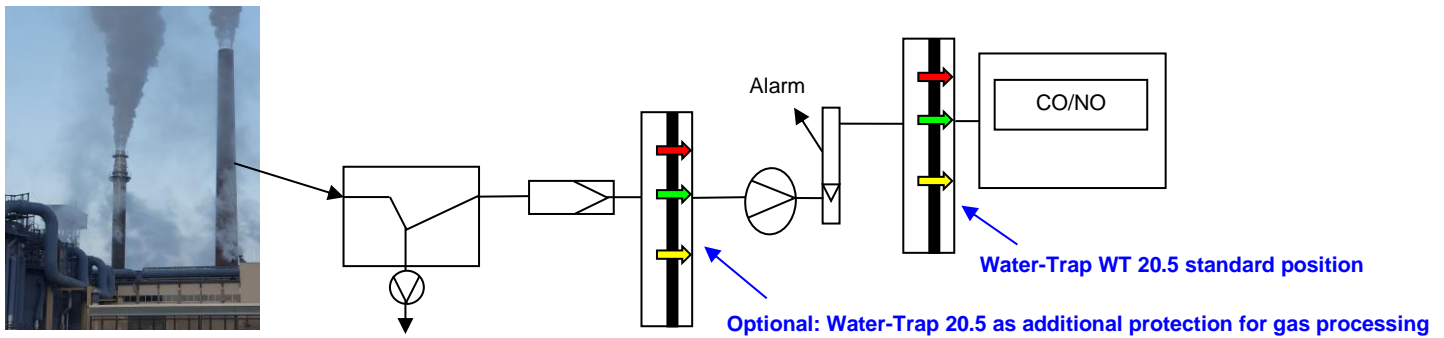

Advantage:

The analyser is protected in case of failure of the cooling system (cooler, peristaltic pump). Another Water-Trap can be used for protecting the gas processing.

Sample application 2: Strip systems

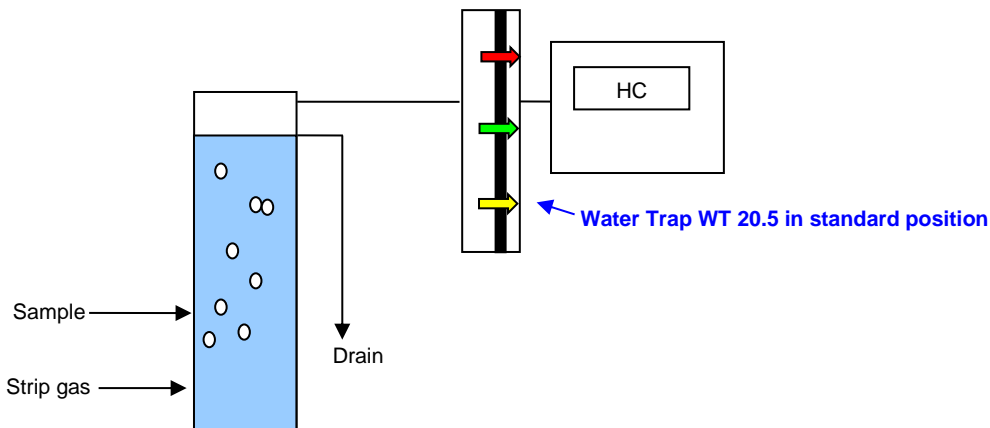

Advantage: In case of a clogged flow, the HC-FID is protected from harmful water

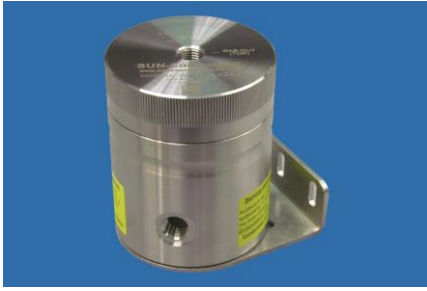

**Water-Acid-Trap with extra fine particle filter
model WT 20.48 KOBE made of stainless steel
model WT 20.48 KOBU made of PVDF**

- For continuous deposition of high quantities of acid during emission measurements, e.g. heavy fuel, when using large diesel engines for ships and for electricity generation



- Secure protection of the gas analyser from condensate and extra fine dust

- For high gas flow rates e.g. in case of engine test benches

- Built-in condensate tank

- Can be used as XL suction filter

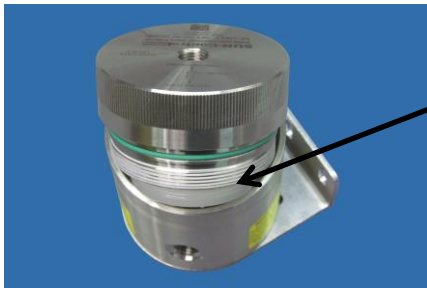

- Cartridge Water-Acid-Trap is exchangeable

- Made in Germany   Hydrogen tested

- Certificates: ATEX 2014/34/EU, leakage tested

Intended use/functional description:

The Water-Acid-Trap WT 20.48 KOBE/KOBU is designed for the following applications:

- Gas-liquid separation after SUN-GT5 series Process-Analytic-Cooler.
- Continuous deposition of high quantities of acids via an in-built bypass, e.g. when using large diesel engines with heavy fuel.
- Engine test benches; a high gas flow rate is possible here.
- Ambient air suction filter; the model 20.48 KOBE/KOBU offers a large filter surface here and thus long service lives.

Condensate can be continuously discharged via a condensate outlet with the help of a peristaltic pump or an automatic separator. Manual extraction via a downstream drain valve is also possible.

The Water-Acid-Trap is installed directly in front of the gas analyser in the piping. If the upstream gas processing (cooler, peristaltic pump, dust filter and the like) fails, the Water-Acid-Trap uses its semi-permeable **SUN-C membrane**® to protect the gas analyser. The membrane separates gases from condensate and extra fine dust.

If it is fully filled, the gas flow will be interrupted. An alarm is indicated via the upstream variable area flowmeter with monitoring. As an option, an electric condensate alarm is available via a built-in float switch.

The Water-Acid-Trap is also known as a "Police filter".

Suitable for the following applications:

- Emission measurements with fossil fuels
- Renewable energy (Hydrogen technology)
- Biogases
- Ambient air monitoring
- Process measurement
- Heat treatments
- Cement, glass, steel, paper industries
- Combustion engines

Not suitable for the following applications:

Condensate with aromatic hydrocarbons, e.g. oils and fuels in refinery process gases.

The models 20.82 E and the model 20.83 E XL with their oil-block membrane and coalescence filters have been designed for this.

Schematic representation:

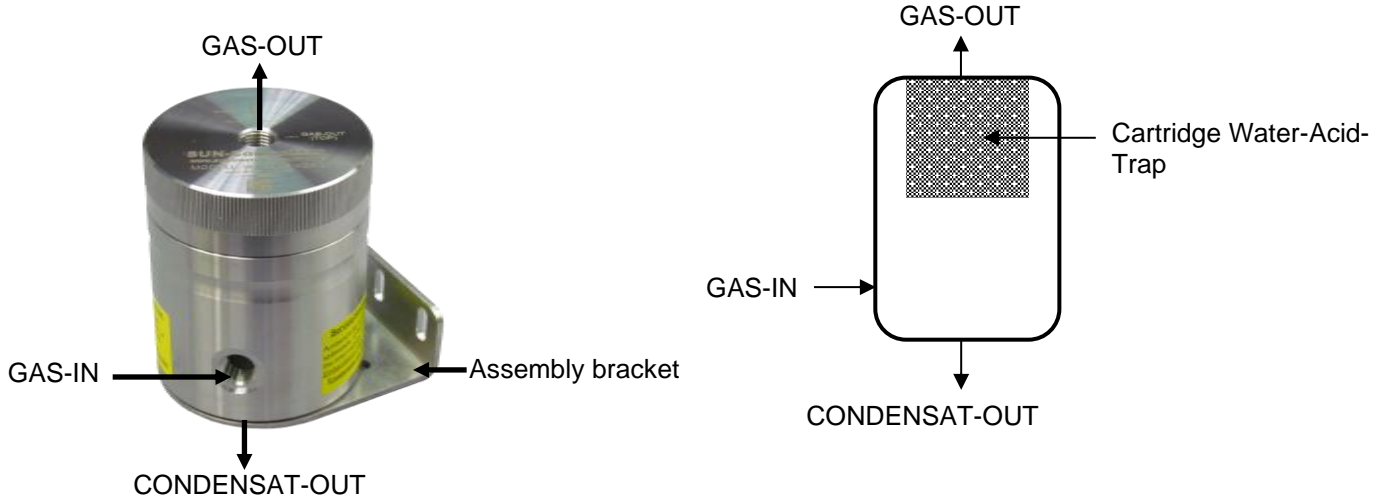

Technical specifications:

Scope of delivery: Housing with integrated cartridge, assembly bracket for wall mounting (option)
 Water pressure membrane: 0 - 1 bar
 Operating pressure for gas: 0 - 100 bar WT 20.48 KOBE / 0 - 1,5 bar WT 20.48 KOBU
 Gas flow: 0 - 10,000 l air/h

Pressure drop at 1,000 l air/h: approx. 12 mbar
 Pressure drop at 5,000 l air/h: approx. 30 mbar
 Diaphragm pore size: < 0.1 µm
 Operating temperature: 0°C - +90°C

Effective filter area: 550 cm²
 Housing volume: 200 ml

Materials used
 WT 20.48KOBE: Stainless steel type 1.4571 (SS316Ti), PTFE, PP, FKM
 WT 20.48KOBU: PVDF (polyvinylidene fluoride), PTFE, PP, FKM

Dimensions: Diameter 80 mm, length 100 mm
 Gas connections:
 GAS-IN 1/4"G-inside thread
 GAS-OUT 1/4"G-inside thread
 KONDENSAT-OUT 1/4"G-inside thread
 Assembly: Wall mounting with assembly bracket (optional)



Gas explosion proof ATEX: ⚠ II 2G Ex h IIC Gb 0°C ≤ Ta ≤ +90°C (WT 20.48KOBE)
 Dust explosion proof ATEX: ⚠ II 2D Ex h IIIC Db 0°C ≤ Ta ≤ +90°C (WT 20.48 KOBE)
 Gas explosion proof ATEX: ⚠ II 2G Ex h IIB Gb 0°C ≤ Ta ≤ +90°C (WT 20.48 KOBU)
 Helium leakage test: 2 x 10⁻⁸ mbar l/s

Language operating instructions: German and English (included in the scope of delivery)
 Spanish, Italian, French, Russian upon request
 Certificates/attestations: certificate of conformity ATEX 2014/34/EU, Helium leakage test attestation

Helium leakage test: (WT 20.48 KOBE)

The product line has been subjected to a helium leak test. Single attestation on request

Article numbers:

protection of utility patents DE 20 2016 100 476

Article	Article number
Water-Acid-Trap WT 20.48 KOBE material stainless steel , as per technical specifications	WT2048KOBE
Water-Acid-Trap WT 20.48 KOBE XL such as WT 20.48 KOBE, with housing volume (condensate tank) 750 ml	WT2048KOBEXL
Water-Acid-Trap WT 20.48 KOBU material PVDF , as per technical specifications	WT2048KOBU
Option:	
1 unit of stainless steel assembly bracket for wall mounting	MONWIWT2048
Spare parts:	
Cartridge Water-Acid-Trap	KAWT2048
1 unit O-ring FKM, colour green	OR2048FKM
1 unit O-ring FFKM, colour black	OR2048FFKM

Sample application: Continuous acid deposition in case of large diesel engines

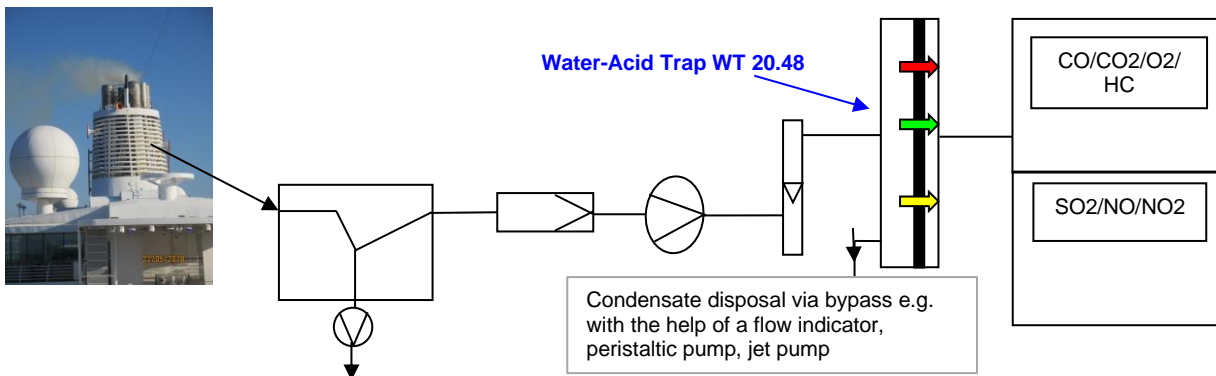

In case of high sulphur content in fossil fuels, e.g. heavy fuel, the products help the acid filter and absorber only under certain circumstances. Acid drops are often found even after the gas processing. They are deposited via the Water-Acid-Trap WT 20.48 and continuously discharged via the bypass.

Sample application: Engine test bench

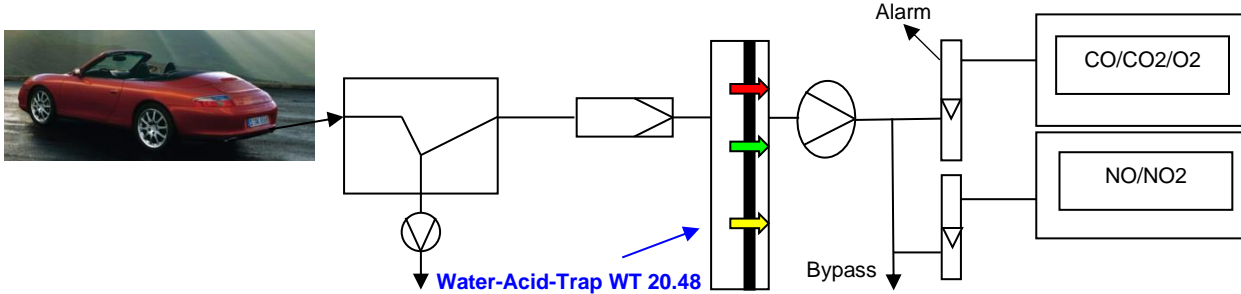



Suction filter **without** protection against contact

Suction filter with integrated Water-Trap model WT 20.5 A

- Secure protection of the gas analyser from rain, extra fine dust and insects due to a large membrane surface
- Low costs for reliable safety
- Protection when flushing the housing

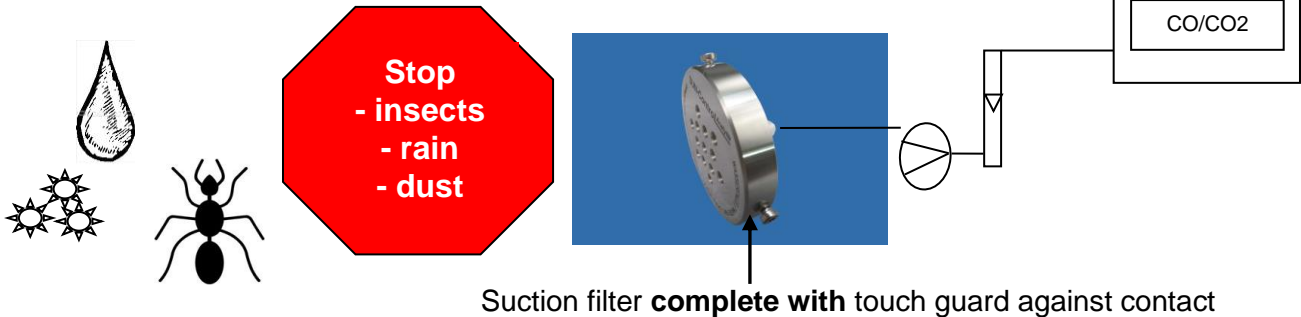

Suction filter **complete with** touch guard against contact

Functional description:

The suction filter with an integrated Water-Trap is installed in the piping, directly at the sampling location (tunnel, basement garage, shipping container for foodstuffs, greenhouses, etc.). Impurities, rain and insects are retained reliably. Can also be used as protection when flushing the housing.

Technical specifications:

Scope of delivery: Suction filter, connection adapter (option), protection cover (option)
 Water pressure membrane: 0 - 2 bar
 Operating pressure for gas: 0 - 2 bar
 Gas flow: 0 - 400 l air/h

Pressure drop at 100 l air/h: approx. 10 mbar
 Pressure drop at 400 l air/h: approx. 40 mbar
 Diaphragm pore size: < 0.1 µm
 Operating temperature: 0°C - +90°C

Effective filter area: 25 cm²
 Housing volume: 5 ml
 Materials used: PTFE, PP, Touch guard made of stainless steel 1.4301
 Dimensions: Diameter 70 mm, length 120 mm
 Gas connection: 1/8" NPT outside thread

Gas explosion proof ATEX:  II 2G Ex h IIB Gb 0°C ≤ Ta ≤ +90°C attestation EPS 19 ATEX 2 177 U
 Assembly: Mounting in the existing piping
 Operating instructions: German and English

Article numbers:

protection of utility patents DE 20 2016 100 476

Article	Article number
Suction filter with integrated Water-Trap WT 20.5 A complete. With protection against contact , gas connection 1/8" NPT outside thread	WT205AKP
Suction filter with integrated Water-Trap WT 20.5 A spare part. Without protection against contact , gas connection 1/8" NPT outside thread	WT205AET
1 unit of connection adapter with 1/8" NPT inside thread connection for screwed hose connection 6/4 mm	VE18N64-1



Water-Oil-Trap with extra fine particle filter
model WT 20.83 PVDF XL
model WT 20.83 PVDF EL XL
model WT 20.83 PFA XL

- Advantageous combination of filter + membrane
- With Dual-Membrane-System[®] to stop of water, acid, alkali, liquid hydrocarbons and extra fine dust
- “Easy Change System” of the inner diaphragm
 After removing the cover screws, the diaphragm can be replaced quickly and effortlessly
 It is not necessary to remove the screw connections
- All gas connections on the lower part of the housing



- Built-in XL filter for particle and permanent liquid deposition
- Bypass function built-in
- Made in Germany  



Functional description:

The Water-Oil-Trap is used as a protection of gas analysers from liquids (Water, acid, alkali, liquid hydrocarbons) and particles. A bypass connection is integrated.

The Water-Oil-Trap is installed directly in front of the gas analyser in the piping. If the upstream gas processing (cooler, peristaltic pump, dust filter and the like) fails, the Water-Oil-Trap uses its semi-permeable membrane with **SUN-C Dual Membrane System**[®] protect the gas analyser. The membrane separates gases from condensate and extra fine dust. The Water-Oil-Trap is designed as a **bypass filter**. The main gas flow can be discharged again via the bypass; a partial current (1:2 to 1:20) will be provided to the analyser. This results in quick response times of the analyser. Condensate carried along is also discharged via the bypass. The aligned incoming flow of the membrane has another additional **self-cleaning effect**. An additional coalescence filter is integrated and helps to deposit oil and aerosols. Particles are also absorbed. An alarm is indicated via the upstream variable area flowmeter with monitoring. An electrical alarm can be made via a flow rate meter (customer side).

The Water-Oil-Trap is also known as a “Police filter”.

Coalescence effect:

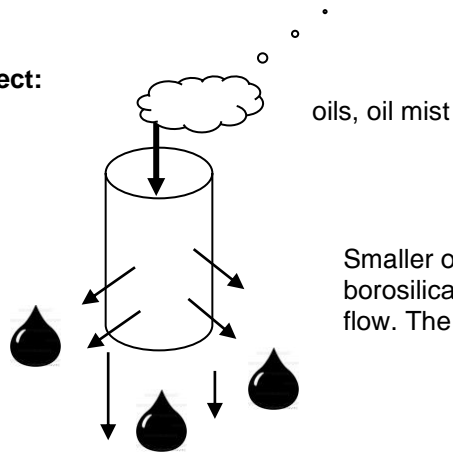

Smaller oil drops and oil mist are “coalesced” with each other by the borosilicate filter. The resulting drops are carried along by the main gas flow. The gas flow is directed from inside to outside

Diagram as bypass filter for deposition of liquids:

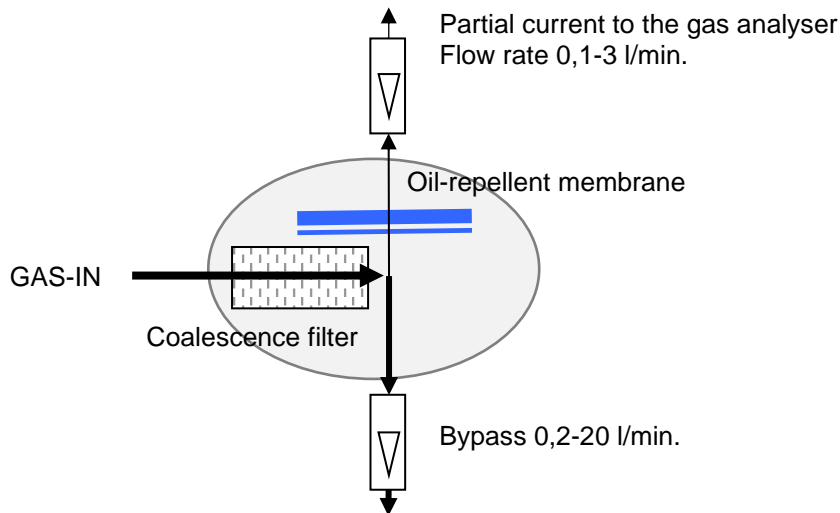

Technical specifications:

Scope of delivery: Housing complete with membrane, filter and, assembly bracket
 Water pressure membrane: 0 - 2,0 bar with DMS (Dual-Membrane-System[®])
 Oil pressure (10W40) membrane: 0 – 0,3 bar with DMS (Dual-Membrane-System[®])
 Gasoline (ROZ 95) Membrane: 0 – 0,2 bar with DMS (Dual-Membrane-System[®])
 The Dual-Membrane-System[®] of the Water-Oil-Traps is a novel membrane system. Condensates such as water, acid, alkali and liquid hydrocarbons, for example, oils and gasolines in refinery process gases are retained.
The design is subject to a legal protection of registered designs (registered number 20 2016 100 476)

Operating pressure for gas: 0 – 3,5 bar, higher pressures on request
 Gas flow: 0 - 180 l air/h
 Pressure drop at 60 l air/h: approx. 20 mbar
 Pressure drop at 120 l air/h: approx. 40 mbar
 Pressure drop at 180 l air/h: approx. 60 mbar

Diaphragm pore size: < 0.1 µm
 Operating temperature: -5°C - +110°C
 Effective filter area: 30 cm²
 Housing volume: 30 ml

Materials used for model:

WT 20.83 **PVDF XL**: PVDF (polyvinylidene fluoride) natural, O-ring FKM (Viton), PTFE, silicate glass, angle bracket: PP

WT 20.83 **PVDF EL XL**: PVDF (polyvinylidene fluoride) with carbon content, electroconductive (on request) (10⁶ Ω/mtr.) Housing colour black, O-ring FKM (Viton), PTFE, silicate glass, angle bracket: PP

WT 20.83 **PFA XL**: PFA (perfluoroalkoxy polymer) natural, O-ring FKM (Viton), PTFE, silicate glass angle bracket: PP

Housing dimensions: Diameter 100 mm, height 80 mm, Depth 160 mm (incl. mounting bracket)

Gas connections: GAS-IN 1/4" NPT-inside thread
 BYPASS 1/4" NPT-inside thread
 GAS-OUT 1/8" NPT-inside thread

Assembly: Wall mounting with assembly bracket (included in scope of delivery)

Assembly advice: Installation of the bypass is recommended.

Consider the max. membrane pressures if no bypass is possible

Language operating German and English (included in the scope of delivery)

instructions: Spanish, Italian, French, Russian upon request

For operation in potentially explosive ambience: on request

Sample application: Natural gas analysis (fuel value determination) with sample preparation:

SUN-Control, Sample Handling, Standard Application Natural Gas

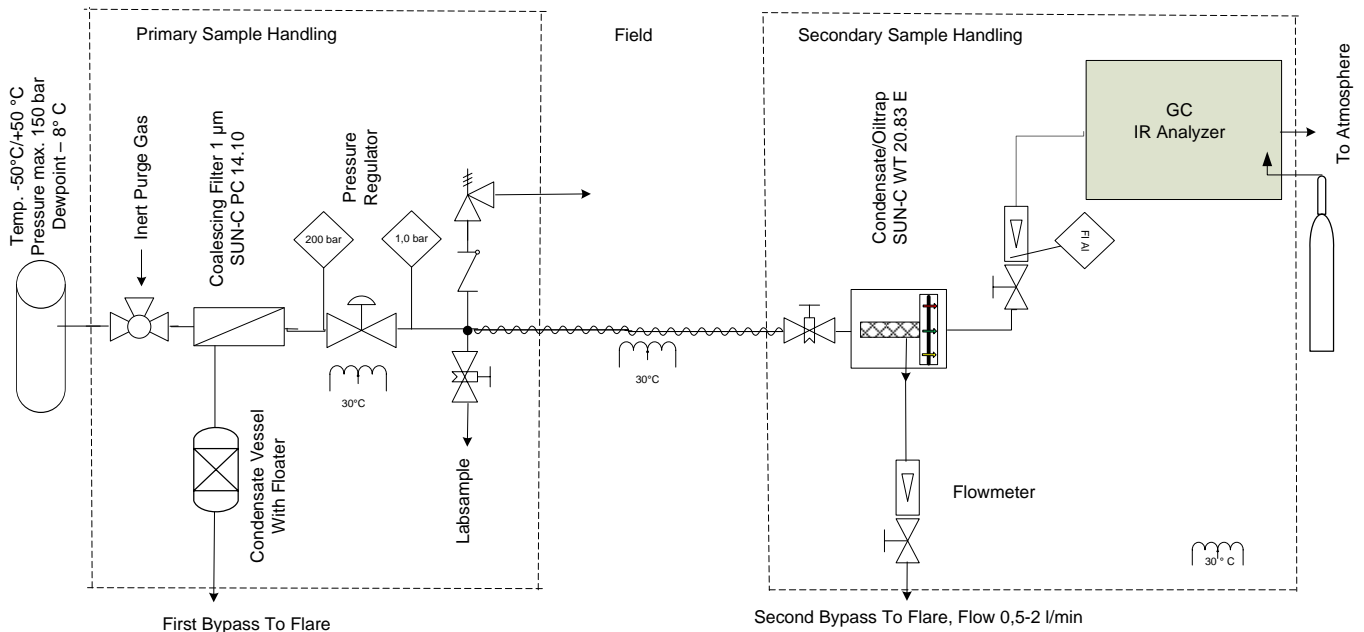

protection of utility patents DE 20 2016 100 476

Article numbers:

Article	Article number
P V D F	
Water-Oil-Trap WT 20.83 PVDF XL material PVDF, as per technical specifications. O-rings FKM (standard)	WT2083PVDFXL
Water-Oil-Trap WT 20.83 PVDF XL material PVDF, as per technical specifications. O-rings PTFE	WT2083PVDFXLORPTFE
Water-Oil-Trap WT 20.83 PVDF XL material PVDF, as per technical specifications. O-rings FFKM	WT2083PVDFXLORFFKM
P F A	
Water-Oil-Trap WT 20.83 PFA XL material PFA, as per technical specifications. O-rings FKM (standard)	WT2083PFAXL
Water-Oil-Trap WT 20.83 PFA XL material PFA, as per technical specifications. O-rings PTFE	WT2083PFAXLORPTFE
Water-Oil-Trap WT 20.83 PFA XL material PFA, as per technical specifications. O-rings FFKM	WT2083PFAXLORFFKM
Spare parts:	
Spare membrane, including white membrane, grey membrane and indicator plate	MEM2083
Set (5 units) coalescence filter	KF2083XL
Set of O-rings FKM Viton (standard), color green	OR2083FKM
Set of O-rings PTFE, color white	OR2083PTFE
Set of O-rings FFKM, color black	OR2083FFKM
Supporting sieve PVDF	STUESI2083PVDF
Supporting sieve PFA	STUESI2083PFA

Note:

- The standard product is equipped with FKM O-rings. For additional information about O-rings, refer to "Informations".
- PTFE O-rings for single use only



Water-Oil-Trap with extra fine particle filter model WT 20.83 E XL, in a stainless steel housing

- Advantageous combination of filter + membrane
- With Dual-Membrane-System® to stop of water, acid, alkali, liquid hydrocarbons and extra fine dust

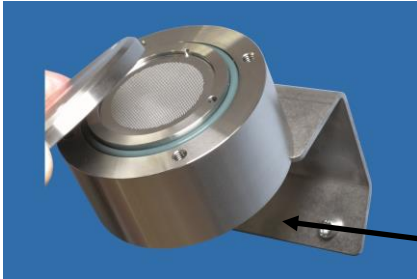

- “Easy Change System” of the inner diaphragm
After removing the cover screws, the diaphragm can be replaced quickly and effortlessly
It is not necessary to remove the screw connections

- All gas connections on the lower part of the housing

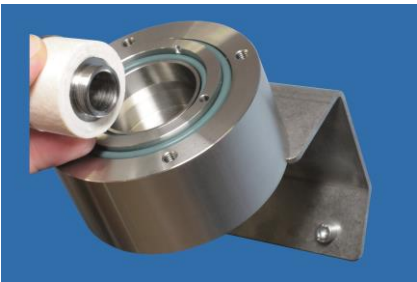

- Built-in XL filter for particle and permanent liquid deposition
- Bypass function built-in
- Made in Germany   Hydrogen tested
- Certificates: 3.1 material quality certificate, ATEX 2014/34/EU, Helium leakage tested

Functional description:

The Water-Oil-Trap is used as a protection of gas analysers from liquids (Water, acid, alkali, liquid hydrocarbons) and particles. A bypass connection is integrated.

The Water-Oil-Trap is installed directly in front of the gas analyser in the piping. If the upstream gas processing (cooler, peristaltic pump, dust filter and the like) fails, the Water-Oil-Trap uses its semi-permeable membrane with **SUN-C Dual Membrane System**® protect the gas analyser. The membrane separates gases from condensate and extra fine dust. The Water-Oil-Trap is designed as a **bypass filter**. The main gas flow can be discharged again via the bypass; a partial current (1:2 to 1:20) will be provided to the analyser. This results in quick response times of the analyser. Condensate carried along is also discharged via the bypass. The aligned incoming flow of the membrane has another additional **self-cleaning effect**. An additional coalescence filter is integrated and helps to deposit oil and aerosols. Particles are also absorbed. An alarm is indicated via the upstream variable area flowmeter with monitoring. An electrical alarm can be made via a flow rate meter (customer side).

The Water-Oil-Trap is also known as a “Police filter”.

Coalescence effect:

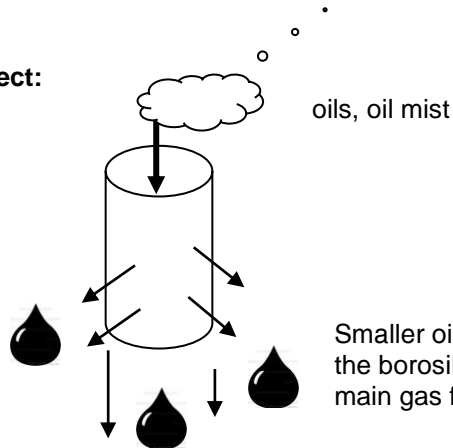
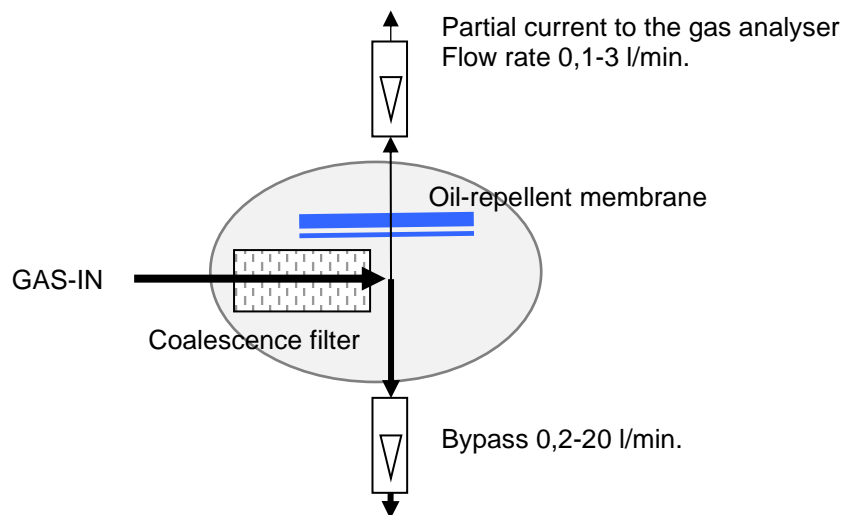

Diagram as bypass filter for deposition of liquids:



Technical specifications:

Scope of delivery: Housing complete with membrane, filter and, wall assembly bracket
 Water pressure membrane: 0 - 2,0 bar with DMS (Dual-Membrane-System[®])
 Oil pressure (10W40) membrane: 0 – 0,3 bar with DMS (Dual-Membrane-System[®])
 Gasoline (ROZ 95) Membrane: 0 – 0,2 bar with DMS (Dual-Membrane-System[®])
 The Dual-Membrane-System[®] of the Water-Oil-Traps is a novel membrane system. Condensates such as water, acid, alkali and liquid hydrocarbons, for example, oils and gasolines in refinery process gases are retained.
The design is subject to a legal protection of registered designs (registered number 20 2016 100 476)

Operating pressure for gas: 0 - 50 bar (for higher pressure refer to model WT 20.83 E XL HD)
 Gas flow: 0 - 180 l air/h
 Pressure drop at 60 l air/h: approx. 20 mbar
 Pressure drop at 120 l air/h: approx. 40 mbar
 Pressure drop at 180 l air/h: approx. 60 mbar

Diaphragm pore size: < 0.1 µm
 Operating temperature: - 20°C - +190°C
 Effective filter area: 30 cm²
 Housing volume: 30 ml
 Materials used: Stainless steel type 1.4571, FKM (Viton), PTFE, silicate glass (filter element)
 Housing dimensions: Diameter 100 mm, height 80 mm, Depth 160 mm (incl. mounting bracket)

Gas connections:	GAS-IN	1/4" NPT inside thread
	BYPASS	1/4" NPT inside thread
	GAS-OUT	1/8" NPT inside thread
Assembly:	Wall mounting with assembly bracket (included in scope of delivery)	
Assembly advice:	Installation of the bypass is recommended. Consider the max. membrane pressures if no bypass is possible	
Gas explosion proof ATEX:	II 2G Ex h IIC Gb	-20°C ≤ Ta ≤ +190°C attestation EPS 19 ATEX 2 178 U
Dust explosion proof ATEX:	II 2D Ex h IIIC Db	-20°C ≤ Ta ≤ +190°C attestation EPS 19 ATEX 2 178 U
Helium leakage test:	2 x 10 ⁻⁸ mbar l/s	
Language operating instructions:	German and English (included in the scope of delivery) Spanish, Italian, French, Russian upon request	
Certificates/attestations:	3.1 material quality certificate, NACE-MR0175-98, certificate of conformity ATEX 2014/34/EU, Helium leakage test attestation	

For operation in potentially explosive ambience:

The products can be used in explosive ambience of Zone 1, Zone 2, Zone 21 und 22.

Allowed the explosion classes IIA, IIB und IIC.

The products have no self-heating during intended operation and can be used in dependency of the maximum permissible media temperature for gases of the temperature class T6.

Helium leakage test:

The product line has been subjected to a helium leak test. Single attestation on request

SUNOX100-process

Oil and grease-free products for applications with 100% oxygen (on request)

Sample application: Natural gas analysis (fuel value determination) with sample preparation:

SUN-Control, Sample Handling, Standard Application Natural Gas

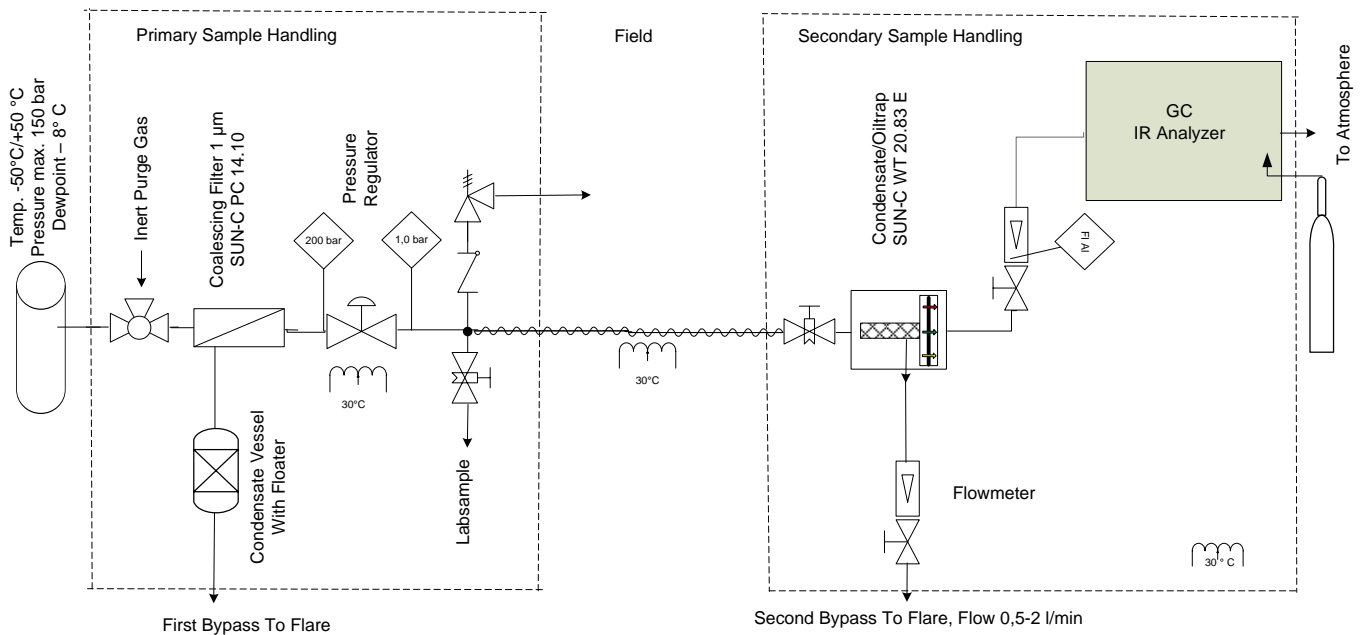

protection of utility patents DE 20 2016 100 476

Article numbers:

Article	Article number
Water-Oil-Trap WT 20.83 E XL. Material stainless steel 1.4571 (316 Ti), as per technical specifications. O-rings FKM (standard)	WT2083EXL
Water-Oil-Trap WT 20.83 E XL. Material stainless steel 1.4571 (316 Ti), as per technical specifications. O-rings PTFE	WT2083EXLORPTFE
Water-Oil-Trap WT 20.83 E XL. Material stainless steel 1.4571 (316 Ti), as per technical specifications. O-rings FFKM	WT2083EXLORFFKM
Water-Oil-Trap material Hastelloy HC 22 or 1.4462-Super Duplex	
Spare parts:	
Spare membrane, including white membrane, grey membrane and indicator plate	MEM2083
Set (5 units) of coalescence filter	KF2083XL
Set of O-rings FKM Viton (standard), color green	OR2083FKM
Set of O-rings PTFE, color white	OR2083PTFE
Set of O-rings FFKM, color black	OR2083FFKM
Supporting sieve	STUESI2083
Spare parts kit 1 , including: 1 x MEM2083, 1 x OR2083FKM, 1 x STUESI2083, 1 x KF2083XL	ET1PA2083EXL

Note:

- The standard product is equipped with FKM O-rings. For additional information about O-rings, refer to "Informations".
- PTFE O-rings for single use only

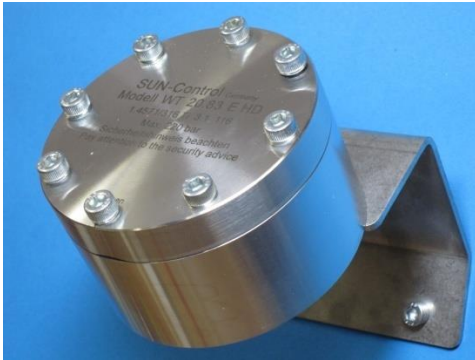

Water-Oil-Trap model WT 20.83 E XL HD (High pressure) up to 220 bar

- Advantageous combination of filter + membrane
- With Dual-Membrane-System[®] to stop of water, acid, alkali, liquid hydrocarbons and extra fine dust

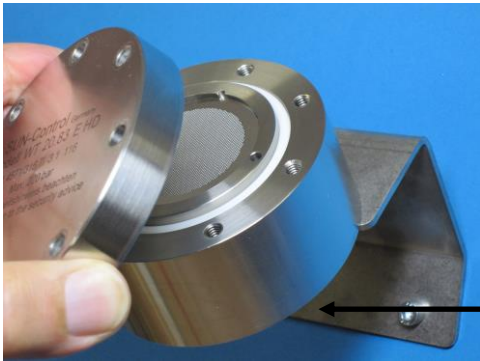

- “Easy Change System” of the inner diaphragm
 After removing the cover screws,
 the diaphragm can be replaced quickly and effortlessly
 It is not necessary to remove the screw connections!

- All gas connections on the lower part of the housing

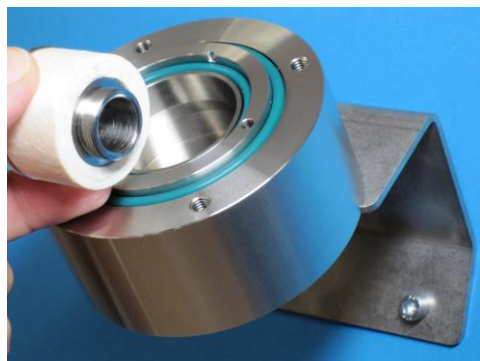

- Built-in XL filter for particle and permanent liquid deposition
- Bypass function built-in
- Made in Germany  
- Certificates: 3.1 material quality certificate, ATEX 2014/34/EU

Technical specifications such as model WT 20.83 E XL with the following deviations:

Max. internal pressure of housing: 220 bar
 Maximum operating temperature: + 5°C/+75°C

Article numbers:

protection of utility patents DE 20 2016 100 476



Article	Article number
Water-Oil-Trap WT 20.83 E XL HD made of 1.4571 stainless steel, as per technical specifications.	WT2083EXLHD
Spare parts:	
Spare membrane, including white membrane, grey membrane, screws, outer and inner O-ring	MEM2083HD
Set (5 units) of XL-coalescence filter	KF2083XL
Supporting sieve	STUESI2083

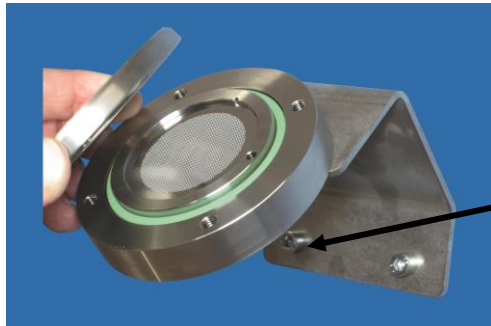

Water-Oil-Trap with extra fine particle filter model WT 20.82 E in a stainless steel housing

- With Dual-Membrane-System[®] to stop of water, acid, alkali, liquid hydrocarbons and extra fine dust
- Bypass function provided



- “Easy Change System” of the inner diaphragm
 After removing the cover screws, the diaphragm can be replaced quickly and effortlessly. It is not necessary to remove the screw connections
- All gas connections on the lower part of the housing
- Made in Germany   **H**ydrogen tested
- Certificates: 3.1 material quality certificate, ATEX 2014/34/EU, Helium leakage tested

Functional description:

The Water-Oil-Trap is used as a protection of gas analysers from liquids (Water, acid, alkali, liquid hydrocarbons) and particles. A bypass connection is integrated.

The Water-Oil-Trap is installed directly in front of the gas analyser in the tubing. If the upstream gas processing (cooler, peristaltic pump, dust filter and the like) fails, the Water-Oil-Trap uses its semi-permeable membrane with **SUN-C Dual Membrane System**[®] to protect the gas analyser. The membrane separates gases from condensate and extra fine dust. The Water-Oil-Trap is designed as a **bypass filter**. The main gas flow can be discharged again via the bypass; a partial current (1:2 to 1:20) will be provided to the analyser. This results in quick response times of the analyser. Condensate carried along is also discharged via the bypass. The aligned incoming flow of the membrane has another additional **self-cleaning effect**. An alarm is indicated via the upstream variable area flowmeter with monitoring (customer side).

The Water-Oil-Trap is also known as a “Police filter”.

Schematic representation:

Traditional protection:

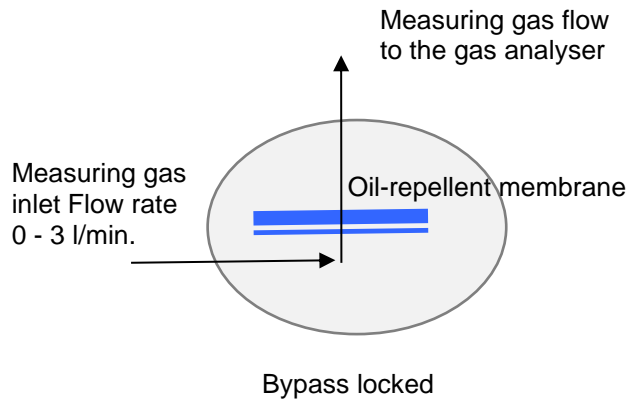

Bypass filter:

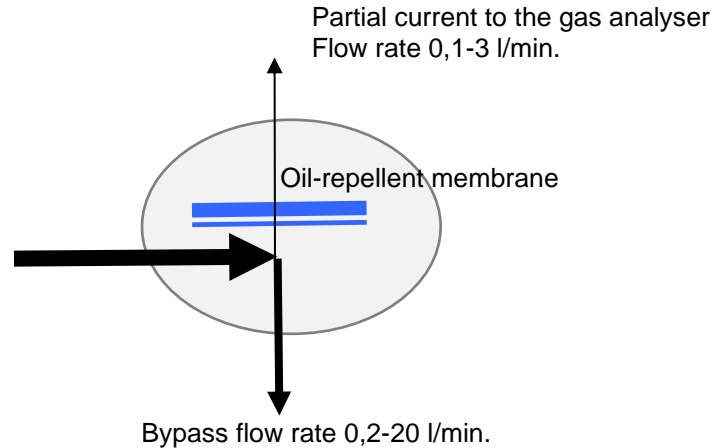

Technical specifications:

Scope of delivery: Housing complete with membrane, filter and, wall assembly bracket
 Water pressure membrane: 0 - 2,0 bar with DMS (Dual-Membrane-System[®])
 Oil pressure (10W40) membrane: 0 – 0,3 bar with DMS (Dual-Membrane-System[®])
 Gasoline (ROZ 95) Membrane: 0 – 0,2 bar with DMS (Dual-Membrane-System[®])

The Dual-Membrane-System[®] of the Water-Oil-Traps is a novel membrane system. Condensates such as water, acid, alkali and liquid hydrocarbons, for example, oils and gasolines in refinery process gases are retained.

The design is subject to a legal protection of registered designs (registered number 20 2016 100 476)

Operating pressure for gas: 0 - 50 bar
 Gas flow: 0 - 180 l air/h
 Pressure drop at 60 l air/h: approx. 20 mbar
 Pressure drop at 120 l air/h: approx. 40 mbar
 Pressure drop at 180 l air/h: approx. 60 mbar

Diaphragm pore size: < 0.1 µm
 Operating temperature: - 20°C - +190°C
 Effective filter area: 30 cm²
 Housing volume: 15 ml
 Materials used: Stainless steel type 1.4571, FKM (Viton), PTFE
 Wall mounting bracket (option): Stainless steel type 1.4301

Housing dimensions: Diameter 100 mm, height 80 mm; Depth 160 mm (incl. mounting bracket)

Gas connections: GAS-IN 1/4" NPT inside thread
 BYPASS 1/4" NPT inside thread
 GAS-OUT 1/8" NPT inside thread

Assembly: Wall mounting with assembly bracket (included in scope of delivery)

Assembly advice: Installation of the bypass is recommended.
 Consider the max. membrane pressures if no bypass is possible

Gas explosion proof ATEX: II 2G Ex h IIC Gb -20°C ≤ Ta ≤ +190°C attestation EPS 19 ATEX 2 178 U

Dust explosion proof ATEX: II 2D Ex h IIIC Db -20°C ≤ Ta ≤ +190°C attestation EPS 19 ATEX 2 178 U

Helium leakage test: 2 x 10⁻⁸ mbar l/s

Language operating instructions: German and English (included in the scope of delivery)

Spanish, Italian, French, Russian upon request

Certificates/attestations: 3.1 material quality certificate, NACE-MR0175-98, certificate of conformity ATEX 2014/34/EU, Helium leakage test attestation

For operation in potentially explosive ambience:

The products can be used in explosive ambience of Zone 1, Zone 2, Zone 21 und 22.

Allowed the explosion classes IIA, IIB und IIC.

The products have no self-heating during intended operation and can be used in dependency of the maximum permissible media temperature for gases of the temperature class T6.

Helium leakage test:

The product line has been subjected to a helium leak test. Single attestation on request

SUNOX100-process

Oil and grease-free products for applications with 100% oxygen (on request)

Article numbers:

protection of utility patents DE 20 2016 100 476

Article	Article number
Water-Oil-Trap WT 20.82 E, Material stainless steel 1.4571 (316 Ti), as per technical specifications. O-rings FKM (Standard)	WT2082E
Water-Oil-Trap WT 20.82 E, Material stainless steel 1.4571 (316 Ti), as per technical specifications. O-rings PTFE	WT2082EORPTFE
Water-Oil-Trap WT 20.82 E, Material stainless steel 1.4571 (316 Ti), as per technical specifications. O-rings FFKM	WT2082EORFFKM
Water-Oil-Trap material Hastelloy HC 22 or 1.4462-Super Duplex	
Spare parts:	
Spare membrane, including white membrane, grey membrane and indicator plate	MEM2082
Set of O-rings FKM Viton (standard), color green	OR2082FKM
Set of O-rings PTFE, color white	OR2082PTFE
Set of O-rings FFKM, color black	OR2082FFKM
Supporting sieve	STUESI2082
Spare parts kit 1, including: 1 x MEM2082, 1 x OR2082FKM, 1 x STUESI2082,	ET1PA2082

Note:

- The standard product is equipped with FKM O-rings. For additional information about O-rings, refer to "Informations".
- PTFE O-rings for single use only

Sample application for flue gas analysis with bypass:

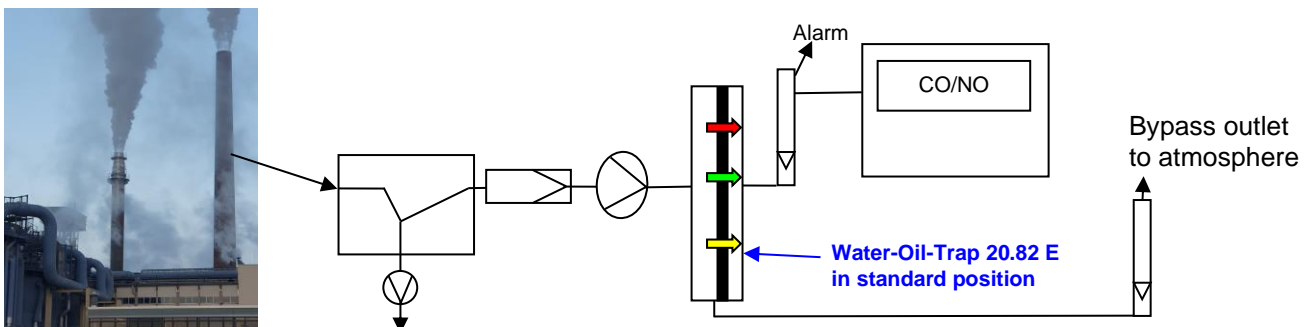



Water-Oil-Trap with extra fine particle filter model WT 30.5 E in a stainless steel housing

- With Dual-Membrane-System® to stop of water, acid, alkali, liquid hydrocarbons and extra fine dust
- Bypass integrated

- Minimum gas volume of just 2 ml

- Especially for gas-chromatographs Bypass integrated

- “Easy Change System” of the inner diaphragm
After removing the cover screws,
the diaphragm can be replaced quickly and effortlessly
It is not necessary to remove the screw connections



- All gas connections on the lower part of the housing

- Made in Germany   **H**ydrogen tested

- Certificates: 3.1 material quality certificate, ATEX 2014/34/EU, Helium leakage tested

Functional description:

The Water-Oil-Trap is used as a protection of gas analysers from liquids (Water, acid, alkali, liquid hydrocarbons) and particles. A bypass connection is integrated.

The Water-Oil-Trap is installed directly in front of the gas analyser in the tubing. If the upstream gas processing (cooler, peristaltic pump, dust filter and the like) fails, the Water-Oil-Trap uses its semi-permeable membrane with **SUN-C Dual Membrane System®** to protect the gas analyser. The membrane separates gases from condensate and extra fine dust. The Water-Oil-Trap is designed as a **bypass filter**. The main gas flow can be discharged again via the bypass; a partial current (1:2 to 1:20) will be provided to the analyser. This results in quick response times of the analyser. Condensate carried along is also discharged via the bypass. The aligned incoming flow of the membrane has another additional **self-cleaning effect**. An alarm is indicated via the upstream variable area flowmeter with monitoring (customer side).

The Water-Oil-Trap is also known as a “Police filter”.

Schematic representation:

Traditional protection:

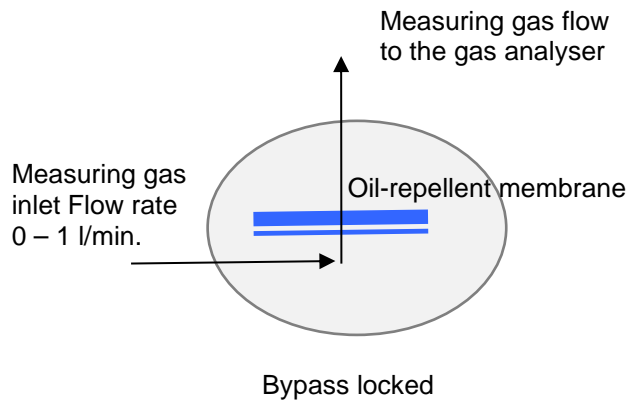

Bypass filter:

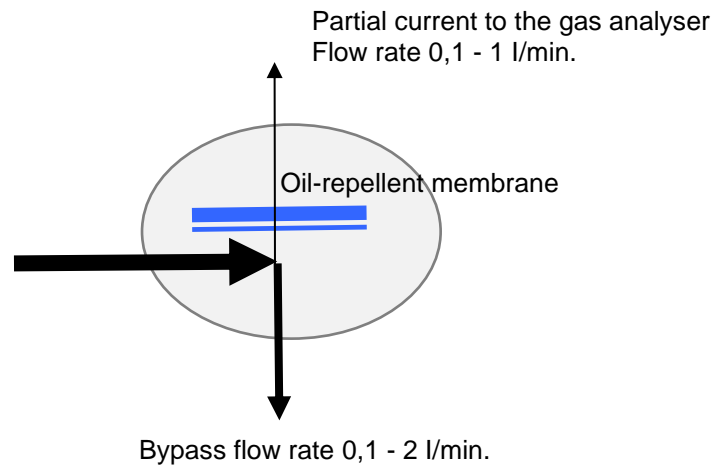

Technical specifications:

Scope of delivery: Housing complete with membrane, filter and, wall assembly bracket
 Water pressure membrane: 0 - 2,0 bar with DMS (Dual-Membrane-System[®])
 Oil pressure (10W40) membrane: 0 - 0,3 bar with DMS (Dual-Membrane-System[®])
 Gasoline (ROZ 95) Membrane: 0 - 0,2 bar with DMS (Dual-Membrane-System[®])

The Dual-Membrane-System[®] of the Water-Oil-Traps is a novel membrane system. Condensates such as water, acid, alkali and liquid hydrocarbons, for example, oils and gasolines in refinery process gases are retained.
The design is subject to a legal protection of registered designs (registered number 20 2016 100 476)

Operating pressure for gas: 0 - 50 bar (higher pressures on request)
 Gas flow: 0 - 60 l air/h
 Pressure drop at 15 l air/h: approx. 30 mbar
 Pressure drop at 30 l air/h: approx. 60 mbar
 Pressure drop at 60 l air/h: approx. 130 mbar

Diaphragm pore size: < 0.1 µm
 Operating temperature: - 20°C - +190°C
 Effective filter area: 12 cm²
 Housing volume: 2 ml
 Materials used: Stainless steel type 1.4571, FKM (Viton), PTFE
 Wall mounting bracket (option): Stainless steel type 1.4301

Housing dimensions: Diameter 60 mm, height 60 mm, Depth 100 mm (incl. mounting bracket)
 Gas connections: GAS-IN 1/8" NPT inside thread
 BYPASS 1/8" NPT inside thread
 GAS-OUT 1/8" NPT inside thread

Assembly: Wall mounting with assembly bracket (included in scope of delivery)
 Assembly advice: Installation of the bypass is recommended.
 Consider the max. membrane pressures if no bypass is possible

Gas explosion proof ATEX: Ⓜ II 2G Ex h IIC Gb -20°C ≤ Ta ≤ +190°C attestation EPS 19 ATEX 2 178 U
 Dust explosion proof ATEX: Ⓜ II 2D Ex h IIIC Db -20°C ≤ Ta ≤ +190°C attestation EPS 19 ATEX 2 178 U
 Helium leakage test: 2 x 10⁻⁷ mbar l/s
 Language operating instructions: German and English (included in the scope of delivery)
 Spanish, Italian, French, Russian upon request
 Certificates/attestations: 3.1 material quality certificate, NACE-MR0175-98, certificate of conformity
 ATEX 2014/34/EU, Helium leakage test attestation

For operation in potentially explosive ambience:

The products can be used in explosive ambience of Zone 1, Zone 2, Zone 21 und 22.
Allowed the explosion classes IIA, IIB und IIC.

The products have no self-heating during intended operation and can be used in dependency of the maximum permissible media temperature for gases of the temperature class T6.

Helium leakage test:

The product line has been subjected to a helium leak test. Single attestation on request

SUNOX100-process

Oil and grease-free products for applications with 100% oxygen (on request)

Article numbers:

protection of utility patents DE 20 2016 100 476

Article	Article number
Water-Oil-Trap WT 30.5 E Material stainless steel 1.4571 (316 Ti), as per technical specifications. O-rings FKM (standard)	WT305E
Water-Oil-Trap WT 30.5 E Material stainless steel 1.4571 (316 Ti), as per technical specifications. O-rings PTFE	WT305EORPTFE
Water-Oil-Trap WT 30.5 E Material stainless steel 1.4571 (316 Ti), as per technical specifications. O-rings FFKM	WT305EORFFKM
Option:	
1 unit of assembly adapter for front panel assembly, Material plastic (PTFE)	ADAPFROP305
Spare parts:	
Spare membrane, including white membrane, grey membrane and indicator plate	MEM305
Set of O-rings FKM Viton (standard), color green	OR305FKM
Set of O-rings PTFE, color white	OR305PTFE
Set of O-rings FFKM, color black	OR305FFKM
Supporting sieve	STUESI305
Spare parts kit 1, including: 1 x MEM305, 1 x OR305FKM, 1 x STUESI305	ET1PA305

Note:

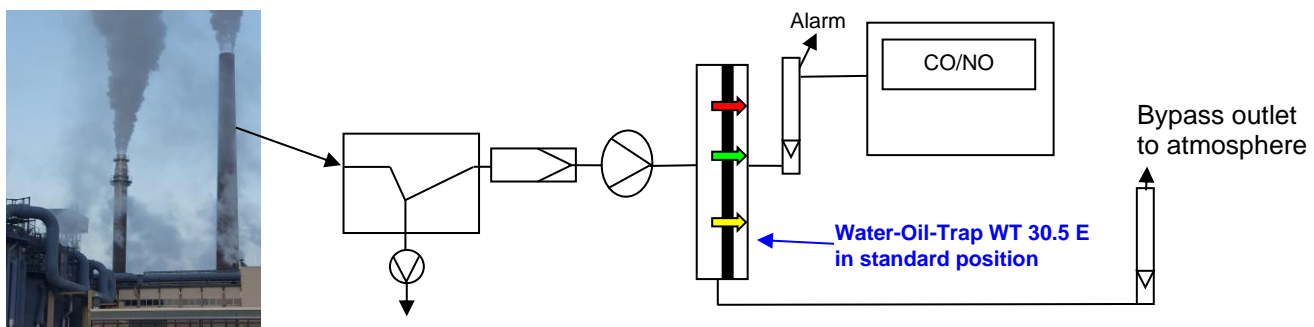

- The standard product is equipped with FKM O-rings. For additional information about O-rings, refer to "Informations".
- PTFE O-rings for single use only

Sample application for flue gas analysis with bypass:

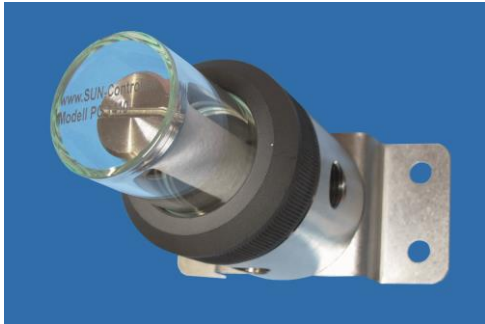



Particle and coalescence filter model PC 1410 E in a stainless steel housing

- One body two filtermethodes
Separation of liquids - particle filter
- Less space is required horizontal mounting
- Can be used up to 350 bar and +200°C
- Gas connections on the body sub frame
- „Easy-Filter-Change-System“
Simple change of filter element from the front side
It is not necessary to remove the screw connections
- Self-cleaning via bypass connection
- Made in Germany    Hydrogen tested
- Certificates: 3.1 material quality certificate, ATEX 2014/34/EU, Helium leakage tested

Functional description:

The PC 1410 model is used in the gas processing during the process gas analytics. The horizontal installation position allows less space requirement. Thanks to different filter elements, gases/liquids can be filtered (particle filter function) or liquids/aerosols can be deposited (coalescence filter function). All the gas connections have been provided for this. The filter housing can be rotated by 360° such that all the connection variants of the gas inlets and gas outlets are possible. The filter element is exchanged in a very service-friendly manner from the front side of the filter. A fussy removal of the screw connections is no longer necessary as all the gas connections are located on the firmly mounted filter base. The filter element is blocked by a retaining screw and thus cannot fall out inadvertently. The possibility of connecting a bypass is provided.

Comparison of the traditional filter technology with the new SUN-Control-Analytik filter

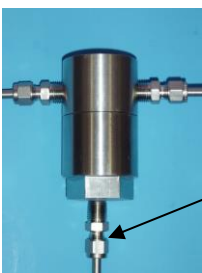

The image shows a traditional bypass/coalescence filter. The disadvantages of the design are:

- Huge space requirement
- The lower screw connection must be removed at the time of changing the filter
- There is a risk of leakage
- Risk of injury during the discharge of corrosive liquids



The new filter model PC 1410 by SUN-Control-Analytik is mounted horizontally. All the gas connections are attached on the lower side of the filter, so that the compact filter unit saves a lot of space. It is not necessary to remove the screw connections when changing the filter.

Schematic representation of particle filtration:

Flow direction through the filter element from **outside to inside**

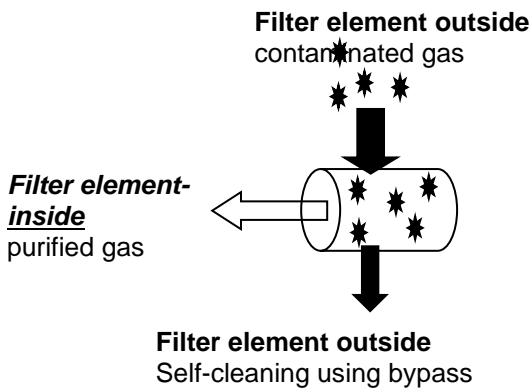

Schematic representation of coalescence filtration (liquid deposition):

Flow direction through the filter element from **inside to outside**

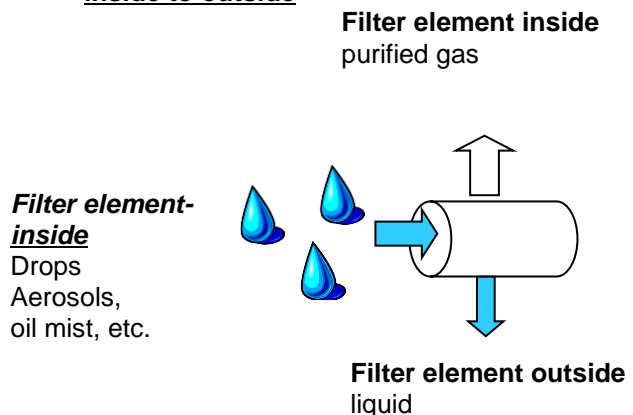

Technical specifications:

Scope of delivery: Housing, retaining screw for filter element, O-ring FKM (Viton) assembly bracket (optional), filter element (optional)
 Materials used: Stainless steel type 1.4571, FKM (Viton), silicate glass (filter element), Duran glass (only D-models)
 Wall mounting bracket (option): Stainless steel type 1.4301
 Operating pressure: 0 - 350 bar. With Duran glass, 0 - 5 bar (till +25°C), 0 - 4 bar (till +80°C)
 Gas flow: 0 - 1000 l air/h
 Pressure drop at 100 l air/h: approx. 5 mbar
 Pressure drop at 200 l air/h: approx. 10 mbar
 Flow rate of the liquid: 400 l water/h at 1 bar pressure
 Flow rate of the liquid: 500 l water/h at 2 bar pressure

Operating temperature: - 20°C - +200 °C (higher temperatures on request)
 With Duran glass: - 5 °C - +80 °C
 Housing dimensions: Diameter 60 mm, length 100 mm
 Housing volume: 35 ml
 Effective filter area: 70 cm²
 Gas connection 1: ¼" NPT inside thread (filter element exterior)
 Gas connection 2: ¼" NPT inside thread (filter element interior)
 Gas connection 3: ¼" NPT inside thread (filter element exterior)
 Gas connection 4: ¼" NPT inside thread (filter element exterior)
 (*G-thread upon request*)

Assembly:
 - Wall mounting using retaining bracket (optional)
 - Front panel mounting using retaining bracket (optional)

Gas explosion proof ATEX: ⚠ II 2G Ex h IIC Gb -20°C ≤ Ta ≤ +200°C Bescheinigung EPS 19 ATEX 2 187 U
 Dust explosion proof ATEX: ⚠ II 2D Ex h IIIC Db -20°C ≤ Ta ≤ +200°C Bescheinigung EPS 19 ATEX 2 187 U
 Helium leakage test: 2 x 10⁻⁹ mbar l/s (PC 1410 E)
 Language operating instructions: German and English (included in the scope of delivery)
 Spanish, Italian, French, Russian upon request
 Certificates/attestations: 3.1 material quality certificate, NACE-MR0175-98, certificate of conformity ATEXv2014/34/EU, Helium leakage test attestation

For operation in potentially explosive ambience:

The products can be used in explosive ambience of Zone 1, Zone 2, Zone 21 und 22.
 Allowed the explosion classes IIA, IIB und IIC.

The products have no self-heating during intended operation and can be used in dependency of the maximum permissible media temperature for gases of the temperature class T6.

Helium leakage test:

The product line has been subjected to a helium leak test. Single attestation on request

SUNOX100-process

Oil and grease-free products for applications with 100% oxygen (on request)

Article numbers:



Filter housing with filter top made of stainless steel:

Article	Article number
Filter housing, material stainless steel 1.4571 (316 Ti), filter top made of stainless steel, with retaining screw for filter element, with O-ring made of FKM (Viton) , without filter element, without assembly bracket	PC1410E
Filter housing, material stainless steel 1.4571 (316 Ti), filter top made of stainless steel, with retaining screw for filter element, with O-ring made of PTFE , without filter element, without assembly bracket	PC1410EORPTFE
Filter housing, material stainless steel 1.4571 (316 Ti), filter top made of stainless steel, with retaining screw for filter element, with O-ring made of FFKM , without filter element, without assembly bracket	PC1410EORFFKM
Filter housing material Hastelloy HC 22 or 1.4462-Super Duplex	

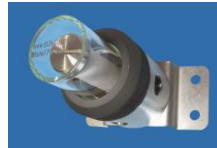

Filter housing with filter top made of Duran glass:

Article	Article number
Filter housing, material stainless steel 1.4571 (316 Ti), with filter top made of Duran glass, with retaining screw for filter element, with O-ring made of FKM (Viton) , without filter element, without assembly bracket	PC1410ED
Filter housing, material stainless steel 1.4571 (316 Ti), with filter top made of Duran glass, with retaining screw for filter element, with O-ring made of PTFE , without filter element, without assembly bracket	PC1410EDORPTFE
Filter housing, material stainless steel 1.4571 (316 Ti), with filter top made of Duran glass, with retaining screw for filter element, with O-ring made of FFKM , without filter element, without assembly bracket	PC1410EDORFFKM
Filter housing material Hastelloy HC 22 or 1.4462-Super Duplex	

Note:

-The standard product is equipped with FKM O-rings. For additional information about O-rings, refer to "Informations".
-PTFE O-rings for single use only

Note: The PC 1410 model has 4 gas connections. If only two are used e.g. when using the particle filter (GAS-IN and GAS-OUT), two blind plugs will be required. If you additionally connect a bypass, only one blind plug is necessary in that case. Please adhere to this in your next order

Ordering aid: what do I need for a complete filter?

1. Filter housing, 2. Filter element, 3. Assembly bracket (you can also use your own system),
4. Blind plug (the filter housing has 4 connections)

Filter elements:

Article	Article number
Set (5 units) of filter elements for particle filtration , Material borosilicate micro glass fibres, pore size 0.1 µm, deposition rate 99.999%	FEPPC1410
Set (5 units) of filter elements for coalescence application (removal of oils and aerosoles) and particle filtration . Material borosilicate micro glass fibres, pore size 0.1 µm, deposition rate 99.999%	FECPC1410
1 unit of filter element for particle filtration, Material PTFE-porous, pore size 1 µm	FEPTFE1PC1410
1 unit of filter element for particle filtration, Material PTFE-porous, pore size 10 µm	FEPTFE10PC1410
1 unit of filter element for particle filtration, Material PTFE-porous, pore size 25 µm	FEPTFE25PC1410
1 unit of filter element for particle filtration, Material PTFE-porous, pore size 50 µm	FEPTFE50PC1410
1 unit of filter element for particle filtration, Material PTFE-porous, pore size 100 µm	FEPTFE100PC1410
1 unit of filter element for filtration of liquids made of stainless steel 1.4401 pore size 1 µm	FESS1PC1410
1 unit for filter element for filtration of liquids made of stainless steel 1.4401 pore size 10 µm	FESS10PC1410
1 unit of filter element for filtration of liquids made of stainless steel 1.4401 pore size 25 µm	FESS25PC1410

Note: Further pore sizes on request.

Options and spare parts:

Article	Article number
1 unit of blind plug made of stainless steel, for locking the unused gas connection	VSPC1410 E
1 unit of assembly bracket made of stainless steel 1.4571 for wall mounting	MONWIWAMOPC1410
1 unit of assembly bracket made of stainless steel 1.4571 for front panel installation	MONWIFROPPC1410
Crash ring made of Plexiglas for Duran glass filter upper part	BSPC1410
1 unit of filter upper part made of Duran glass	FODGPC1410
1 unit of O-ring FKM (Viton) standard, color green	ORPC1410FKM
1 unit of O-ring PTFE, color white	ORPC1410PTFE
1 unit of O-ring FFKM, color black	ORPC1410FFKM

Note: The standard product is equipped with FKM O-rings. For additional information about O-rings, refer to “Information about Water-Traps”

Options:

Assembly bracket made of stainless steel for wall mounting

Item number: MONWIWAMOPC1410

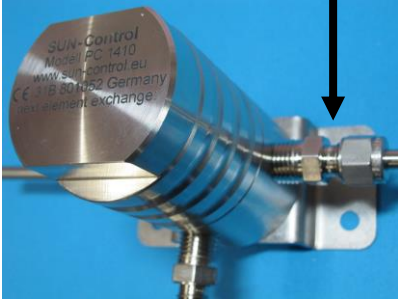

Assembly bracket made of stainless steel for front panel installation

Item number: MONWIFROPPC1410

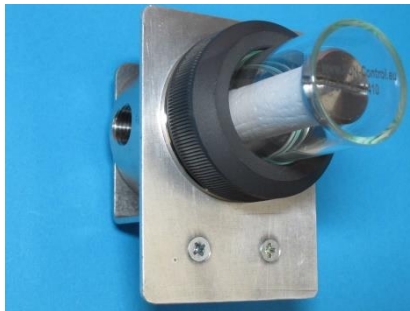
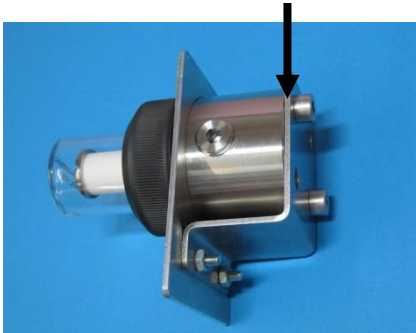

Crash ring made of Plexiglas for Duran glass filter upper part

Item number: BSPC1410

- If the glass breaks, the crash ring offers personal protection
- Pressure relief above 360° gap between round component

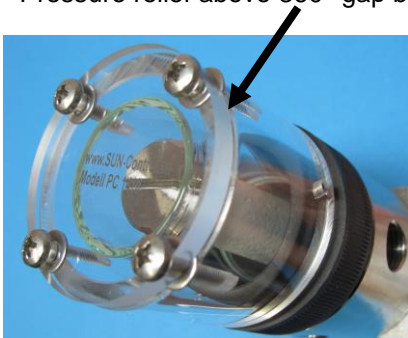



XL size
PC 1410 E XL

Standard size
PC 1410 E



Particle and coalescence filter model PC 1410 E XL in a stainless steel housing



- XL housing variant
- 4 x size of standard product
- One body two filtermethodes
- Separation of liquids - particle filter
- Less space is required horizontal mounting
- Can be used up to 350 bar and +200°C
- Gas connections on the body sub frame
- „Easy-Filter-Change-System“
- Simple change of filter element from the front side
- It is not necessary to remove the screw connections
- Self-cleaning via bypass connection
- Made in Germany  
- Certificates: 3.1 material quality certificate, ATEX 2014/34/EU, Helium leakage tested

Functional description:

The PC 1410 model is used in the gas processing during the process gas analytics. The horizontal installation position allows less space requirement. Thanks to different filter elements, gases/liquids can be filtered (particle filter function) or liquids/aerosols can be deposited (coalescence filter function). All the gas connections have been provided for this. The filter housing can be rotated by 360° such that all the connection variants of the gas inlets and gas outlets are possible. The filter element is exchanged in a very service-friendly manner from the front side of the filter. A fussy removal of the screw connections is no longer necessary as all the gas connections are located on the firmly mounted filter base. The filter element is blocked by a retaining screw and thus cannot fall out inadvertently. The possibility of connecting a bypass is provided.

Technical specifications:

Scope of delivery:	Housing, retaining screw for filter element, O-ring FKM (Viton) assembly bracket (optional), filter element (optional)	
Materials used:	Stainless steel type 1.4571, FKM (Viton), silicate glass (filter element), Duran glass (only D-models)	
Wall mounting bracket (option):	Stainless steel type 1.4301	
Operating pressure:	0 - 350 bar. With Duran glass 0 - 3 bar (till +25°C), 0 - 2 bar (till +80°C)	
Gas flow:	0 - 3000 l air/h	
Pressure drop at 100 l air/h:	approx. 3 mbar	
Pressure drop at 200 l air/h:	approx. 5 mbar	
Flow rate of the liquid:	800 l water/h at 1 bar pressure	
Flow rate of the liquid:	1000 l water/h at 2 bar pressure	
Operating temperature:	- 20°C - +200 °C	
With Duran glass:	- 5 °C - +80°C	
Housing dimensions:	Diameter 75 mm, length 120 mm	
Housing volume:	100 ml	
Effective filter area:	280 cm ²	
Gas connection 1:	¼" NPT inside thread (filter element exterior)	on request ½" inside thread
Gas connection 2:	¼" NPT inside thread (filter element interior)	on request ½" inside thread
Gas connection 3:	¼" NPT inside thread (filter element exterior)	on request ½" inside thread
Gas connection 4:	¼" NPT inside thread (filter element exterior)	on request ½" inside thread
	(G-thread upon request)	
Assembly:	Wall mounting using retaining bracket (optional)	

Gas explosion proof ATEX:  II 2G Ex h IIC Gb -20°C ≤ Ta ≤ +200°C attestation EPS 19 ATEX 2 187 U
Dust explosion proof ATEX:  II 2D Ex h IIIC Db -20°C ≤ Ta ≤ +200°C attestation EPS 19 ATEX 2 187 U

Language operating instructions: German and English (included in the scope of delivery)
Spanish, Italian, French, Russian upon request

Certificates/attestations: 3.1 material quality certificate, NACE-MR0175-98, certificate of conformity
ATEX 2014/34/EU, Helium leakage test attestation

For operation in potentially explosive ambience:

The products can be used in explosive ambience of Zone 1, Zone 2, and Zone 21 und 22.
Allowed the explosion classes IIA, IIB und IIC.
The products have no self-heating during intended operation and can be used in dependency of the maximum permissible media temperature for gases of the temperature class T6.

Article numbers:



Filter housing with filter top made of stainless steel:

Article	Article number
Filter housing, material stainless steel 1.4571 (316 Ti), filter top made of stainless steel, with retaining screw for filter element, with O-ring made of FKM (Viton) , without filter element, without assembly bracket	PC1410EXL
Filter housing, material stainless steel 1.4571 (316 Ti), filter top made of stainless steel, with retaining screw for filter element, with O-ring made of PTFE , without filter element, without assembly bracket	PC1410EXLORPTFE
Filter housing, material stainless steel 1.4571 (316 Ti), filter top made of stainless steel, with retaining screw for filter element, with O-ring made of FFKM , without filter element, without assembly bracket	PC1410EXLORFFKM
Filter housing material Hastelloy HC 22 or 1.4462-Super Duplex	

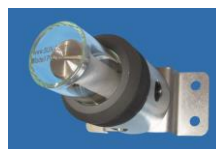

Filter housing with filter top made of Duran glass:

Article	Article number
Filter housing, material stainless steel 1.4571 (316 Ti), with filter top made of Duran glass, with retaining screw for filter element, with O-ring made of FKM (Viton) , without filter element, without assembly bracket	PC1410EDXL
Filter housing, material stainless steel 1.4571 (316 Ti), with filter top made of Duran glass, with retaining screw for filter element, with O-ring made of PTFE , without filter element, without assembly bracket	PC1410EDXLORPTFE
Filter housing, material stainless steel 1.4571 (316 Ti), with filter top made of Duran glass, with retaining screw for filter element, with O-ring made of FFKM , without filter element, without assembly bracket	PC1410EDXLORFFKM
Filter housing material Hastelloy HC 22 or 1.4462-Super Duplex	

Filter elements:

Article	Article number
Set (5 units) of filter elements for particle filtration , Material borosilicate micro glass fibres, pore size 0.1 µm, deposition rate 99.999%	FEPPC1410XL
Set (5 units) of filter elements for coalescence application (removal of oils and aerosols) and particle filtration. Material borosilicate micro glass fibres, pore size 0.1 µm, deposition rate 99.999%	FECPC1410XL
1 unit of filter element for particle filtration, Material PTFE-porous, pore size 1 µm	FEPTFE1PC1410XL
1 unit of filter element for particle filtration, Material PTFE-porous, pore size 10 µm	FEPTFE10PC1410XL
1 unit of filter element for particle filtration, Material PTFE-porous, pore size 25 µm	FEPTFE25PC1410XL
1 unit of filter element for particle filtration, Material PTFE-porous, pore size 50 µm	FEPTFE50PC1410XL
1 unit of filter element for particle filtration, Material PTFE-porous, pore size 100 µm	FEPTFE100PC1410XL
1 unit of filter element for filtration of liquids made of stainless steel 1.4404 pore size 1 µm	FESS1PC1410XL
1 unit of filter element for filtration of liquids made of stainless steel 1.4404 pore size 10 µm	FESS10PC1410XL
1 unit of filter element for filtration of liquids made of stainless steel 1.4404 pore size 25 µm	FESS25PC1410XL

Filter accessories and spare parts:

Article	Article number
1 unit of bling plug made of stainless steel, for locking the unused gas connection	VSPC1410E
1 unit of assembly bracket made of stainless steel 1.4571 for wall mounting	MONWIWAMOPC1410
1 unit of filter upper part, Duran glass	FODGPC1410XL
1 unit of O-ring FKM (Viton) standard, color green	ORPC1410XLFKM
1 unit of O-ring PTFE, color white	ORPC1410XLPTEF
1 unit of O-ring FFKM, color black	ORPC1410XLFFKM

Note:

- The standard product is equipped with FKM O-rings. For additional information about O-rings, refer to "Informations".
- PTFE O-rings for single use only

Note: The PC 1410 model has 4 gas connections. If only two are used e.g. when using the particle filter (GAS-IN and GAS-OUT), two blind plugs will be required. If you additionally connect a bypass, only one blind plug is necessary in that case.

Please adhere to this in your next order

Ordering aid: what do I need for a complete filter?

1. Filter housing
2. Filter element
3. Assembly bracket (you can also use your own system)
4. Blind plug (the filter housing has 4 connections)

Options:

Assembly bracket made of stainless steel for wall mounting

Item number: MONWIWAMOPC1410

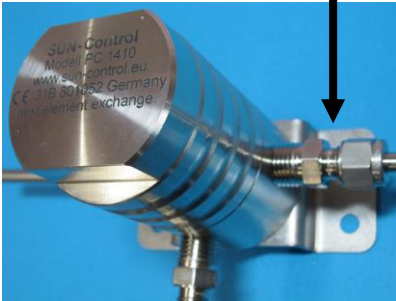



Particle and coalescence filter model PC 1410 PVDF model PC 1410 PVDF EL

- One body two filtermethodes
- Separation of liquids - particle filter
- Less space is required horizontal mounting
- Self-cleaning via bypass connection



- Gas connections on the body sub frame
 „Easy-Filter-Change-System“
 Simple change of filter element from the front side
 To disconnect fittings is not necessary!

- Made in Germany  
- Certificates: ATEX 2014/34/EU

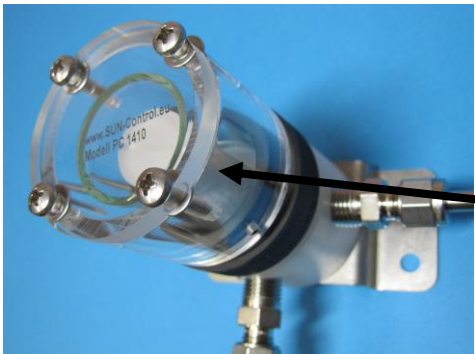

Optional:

- Crash ring made of Plexiglas
- If the glass breaks, the crash ring offers personal protection
- Pressure relief above 360° gap between round component and disc

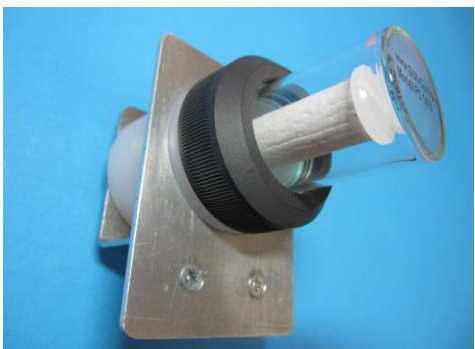

Easy front panel installation using assembly bracket (optional)

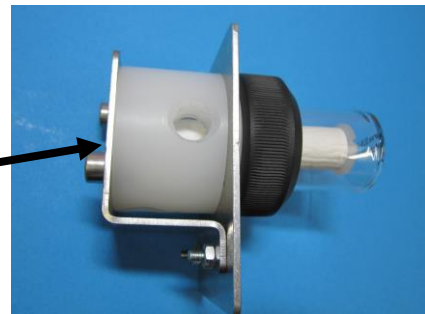

Functional description:

The PC 1410 model is used in the gas processing during the process gas analytics. The horizontal installation position allows less space requirement. Thanks to different filter elements, gases/liquids can be filtered (particle filter function) or liquids/aerosols can be deposited (coalescence filter function). All the gas connections have been provided for this. The filter housing can be rotated by 360° such that all the connection variants of the gas inlets and gas outlets are possible. The filter element is exchanged in a very service-friendly manner from the front side of the filter. A fussy removal of the screw connections is no longer necessary as all the gas connections are located on the firmly mounted filter base. The filter element is blocked by a retaining screw and thus cannot fall out inadvertently. The possibility of connecting a bypass is provided.

Schematic representation of particle filtration:

Flow direction through the filter element from **outside to inside**

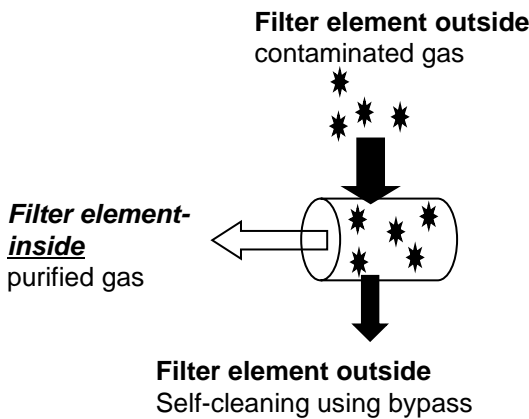

Schematic representation of coalescence filtration (liquid deposition):

Flow direction through the filter element from **inside to outside**

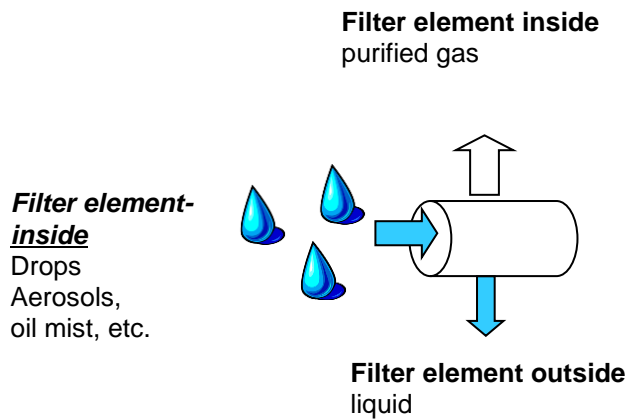

Technical specifications:

Scope of delivery: Housing, retaining screw for filter element, O-ring FKM (Viton) assembly bracket (optional), filter element (optional)

Materials used:
 PC 1410 PVDF: PVDF, FKM, Duran glass (upper part of the filter)
 PC 1410 PVDF EL: PVDF (polyvinylidene fluoride) with carbon content, electroconductive (10⁶ Ω/mtr.) Housing colour black, FKM, Duran glass (upper part of the filter)

Wall mounting bracket (option): Stainless steel type 1.4301

Operating pressure with filter top made of Duran glass: 0 - 5 bar (till +25°C), 0 - 4 bar (till +80°C)

Operating pressure with filter top made of PVDF: 0 - 10 bar

Gas flow: 0 - 1000 l air/h

Pressure drop at 100 l air/h: approx. 5 mbar

Pressure drop at 200 l air/h: approx. 10 mbar

Flow rate of the liquid: 400 l water/h at 1 bar pressure

Flow rate of the liquid: 500 l water/h at 2 bar pressure

Operating temperature: - 5 °C - +80 °C

Housing dimensions: Diameter 60 mm, length 100 mm

Housing volume: 35 ml

Effective filter area: 70 cm²

Gas connection 1: 1/4" G - inside thread (filter element exterior)

Gas connection 2: 1/4" G - inside thread (filter element interior)

Gas connection 3: 1/4" G - inside thread (filter element exterior)

Gas connection 4: 1/4" G - inside thread (filter element exterior)

Assembly: Wall mounting using retaining bracket (optional)
 Front panel mounting using retaining bracket (optional)

Gas explosion proof:  II 2G Ex h IIB Gb -5°C ≤ Ta ≤ +80°C attestation EPS 19 ATEX 2 187 U

Language operating instructions: German and English (included in the scope of delivery)
 Spanish, Italian, French, Russian upon request

Certificates/attestations: certificate of conformity ATEX 2014/34/EU

For operation in potentially explosive ambience:

The products can be used in explosive ambience of Zone 1 and Zone 2.
 Allowed the explosion classes IIA and IIB.

The products have no self-heating during intended operation and can be used in dependency of the maximum permissible media temperature for gases of the temperature class T6.



Article

Article	Article number
Filter housing material PVDF , filter upper part made of Duran glass , with retaining screw for filter element, with O-ring made of FKM (Viton), without filter element, without assembly bracket	PC1410PVDF
Filter housing material PVDF , filter upper part made of PVDF , with retaining screw for filter element, with O-ring made of FKM (Viton), without filter element, without assembly bracket	PC1410PVDFO
Filter housing material PVDF EL , filter upper part made of Duran glass, with retaining screw for filter element, with O-ring made of FKM (Viton), without filter element, without assembly bracket	PC1410PVDFEL
Set (5 units) of filter elements for particle filtration , Material borosilicate micro glass fibres, pore size 0.1 µm, deposition rate 99.999%	FEPPC1410
Set (5 units) of filter elements for coalescence application (removal of oils and aerosols) and particle filtration. Material borosilicate micro glass fibres, pore size 0.1 µm, deposition rate 99.999%	FECPC1410
1 unit of filter element for particle filtration, Material PTFE-porous, pore size 1 µm	FEPTFE1PC1410
1 unit of filter element for particle filtration, Material PTFE-porous, pore size 10 µm	FEPTFE10PC1410
1 unit of filter element for particle filtration, Material PTFE-porous, pore size 25 µm	FEPTFE25PC1410
1 unit of filter element for particle filtration, Material PTFE-porous, pore size 50 µm	FEPTFE50PC1410
1 unit of filter element for particle filtration, Material PTFE-porous, pore size 100 µm	FEPTFE100PC1410
1 unit of blind plug PVDF, for locking the unused gas connection	VSPC1410PVDF
1 unit of assembly bracket made of stainless steel 1.4571 for wall mounting	MONWIWAMOPC1410
1 unit of assembly bracket made of stainless steel 1.4571 for front panel installation	MONWIFROPPC1410
Crash ring made of Plexiglas for Duran glass filter upper part	BSPC1410
Spare parts:	
1 unit of filter upper part made of Duran glass	FODGPC1410
1 unit of O-ring FKM (Viton) standard, color green	ORPC1410FKM
1 unit of O-ring PTFE, color white	ORPC1410PTFE
1 unit of O-ring FFKM	ORPC1410FFKM

Note: The PC 1410 model has 4 gas connections. If only two are used e.g. when using the particle filter (GAS-IN and GAS-OUT), two blind plugs will be required. If you additionally connect a bypass, only one blind plug is necessary in that case. Please adhere to this in your next order.



Acid filter model SF 20.13

- Removal drops of acid and aerosols in flue gas
- Reduction of acid dew point
- Prohibition of corrosion damages on gas analysers
- High deposition rate of 99,99%
- Made in Germany  
- Certificates: ATEX 2014/34/EU

Functional description:

The acid filter is designed for the **removal of aerosols** from the gas flow of predominantly emission measurements. This deals with floating liquid droplets (aerosols), which are deposited in a specially built filter matrix. This takes place with high efficiency because the gas flow is directed from inside to outside by the filter body. Here, the small liquid droplets are coalesced until large drops have formed, which sink in the filter element as a result of gravity and accumulate at the bottom of the glass tank. The service life of the filter element depends on the load of the measuring gas due to solids.

Assembly:

Installation of the acid filter **in front of** the measuring gas cooler. The acid filter must be mounted vertically. The condensate should be able to accumulate in the lower part of the glass tank. The gas connections are marked with arrows. The measuring gas outlet allows a variable immersion depth of the Teflon hose. The deposited liquid is carried along by the measuring gas outlet of the acid filter to the measuring gas cooler. For this, the hose must be inserted in the measuring gas outlet up to a few mm below the lower edge of the filter element in the flask (see image).

Gas flow diagram:

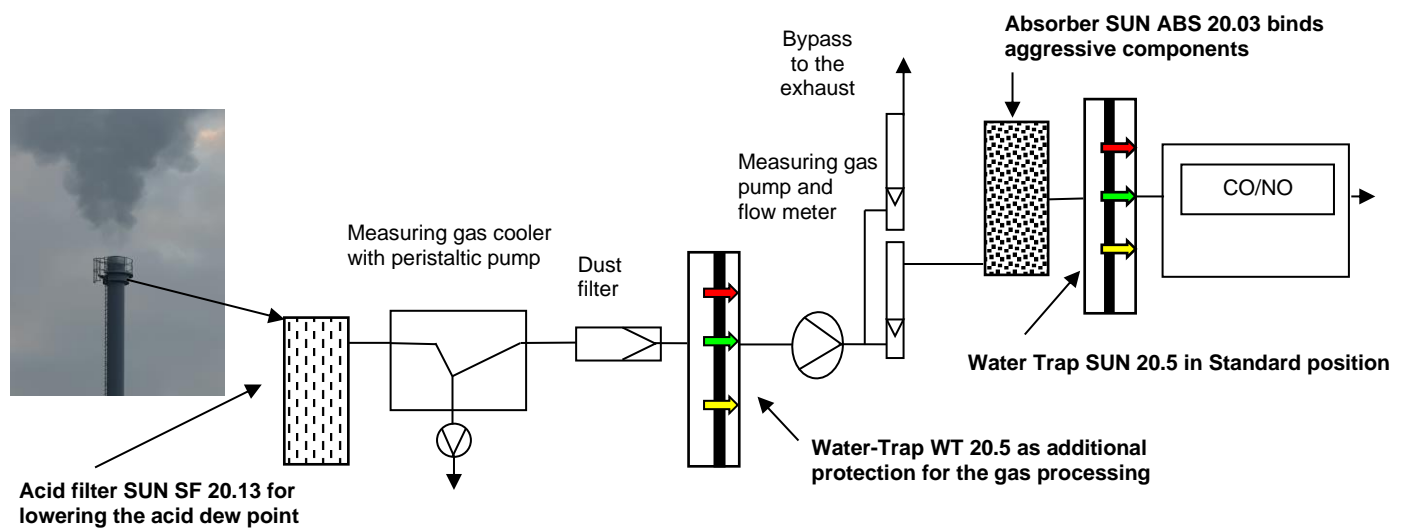

In case of large condensate quantities, the condensate can be disposed of manually using the optimal connection or using an additional peristaltic pump.

Option:
 Connection adapter condensate outlet for 6/4 mm hose connection
 Item number: VEKOSF2013

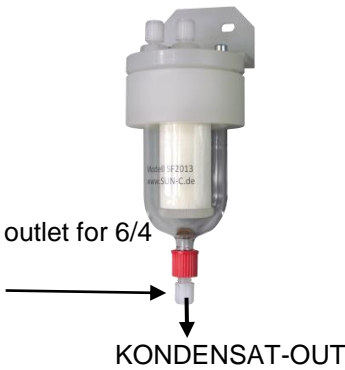

Technical specifications:

Scope of delivery: Housing, filter element, wall assembly bracket
 Materials used: Borosilicate micro glass fibres, PVDF, Duran glass, PP, FKM, ss 1.4301 (bracket)
 Operating pressure: 0 - 500 mbar
 Gas flow: 0 - 300 l air/h

Pressure drop at 300 l air/h: approx. 10 mbar
 Operating temperature: -5°C - +80°C
 Housing dimensions: Diameter 90 mm, length 185 mm
 Housing volume: 135 ml
 Effective filter area: 170 cm²
 Gas connections: GAS-IN 6/4 mm hose fitting
 GAS-OUT 6/4 mm hose fitting
 KONDENSAT-OUT 6/4 mm hose fitting (Option)

Assembly: Wall mounting with assembly bracket (included in scope of delivery)
 Gas explosion proof ATEX: II 2G Ex h IIB Gb -5°C ≤ Ta ≤ +80°C attestation EPS 19 ATEX 2 187 U
 Language operating instructions: German and English (included in the scope of delivery)
 Spanish, Italian, French, Russian upon request
 Certificates/attestations: certificate of conformity ATEX 2014/34/EU

For operation in potentially explosive ambience:

The products can be used in explosive ambience of Zone 1 and Zone 2.
 Allowed the explosion classes IIA and IIB.
 The products have no self-heating during intended operation and can be used in dependency of the maximum permissible media temperature for gases of the temperature class T6.



Article numbers:

Article	Article number
Acid filter complete with retaining bracket and filter element	SF2013
Options:	
Connection adapter condensate outlet for 6/4 mm hose connection	VEKOSF2013
Spare parts:	
1 pair (2 units) of filter elements, material borosilicate micro glass fibres	2FESF2013
5 pairs (10 units) of filter elements, material borosilicate micro glass fibres	10FESF2013
10 pairs (20 units) of filter elements, material borosilicate micro glass fibres	20FESF2013
1 unit of O-ring FKM	ORSF2013FKM
1 unit closing cap red	VKAPSF2013
1 unit glass cover	GGSF2013

Note: Filter elements for acid filter can be offered only in pairs



Particle filter model PF 20.17

- Separation of dust particles
- PTFE filter elements
- High deposition rate of 99,99%
- Made in Germany  
- Certificates: ATEX 2014/34/EU

Functional description:

The filter model PF 20.17 is designed for the removal of dust particle from the measuring gas flow, predominantly of emission measurements. This takes place with high efficiency. There are different pore sizes of filter elements available. Filter elements made of PTFE where chosen as the "high end" material, which prevents memory effects.

Technical specifications:

Scope of delivery: Housing, PTFE filter element, wall assembly bracket
 Materials used: PTFE, Duran glass, PP, FKM, ss 1.4301 (bracket)
 Operating pressure: 0 - 500 mbar
 Gas flow: 0 - 300 l air/h

Pressure drop at 120 l air/h: approx. 10 mbar
 Operating temperature: -5°C - +80°C
 Housing dimensions: Diameter 90 mm, length 165 mm
 Housing volume: 135 ml
 Effective filter area: 170 cm²
 Gas connections: GAS-IN 6/4 mm hose fitting
 GAS-OUT 6/4 mm hose fitting

Assembly: Wall mounting with assembly bracket (included in scope of delivery)
 Language operating instructions: German and English (included in the scope of delivery)
 Spanish, Italian, French, Russian upon request
 Gas explosion proof ATEX:  II 2G Ex h IIB Gb -5°C ≤ Ta ≤ +80°C attestation EPS 19 ATEX 2 187 U

Article numbers:

Article	Article number
Particle filter complete with assembly bracket and PTFE filter element poresize 2µm	PF2017-2
Particle filter complete with assembly bracket and PTFE filter element poresize 25µm	PF2017-25
Particle filter complete with assembly bracket and PTFE filter element poresize 100µm	PF2017-100
Spare parts:	
1 unit PTFE filter element poresize 2µm	FEPTFE2PF2017
1 unit PTFE filter element poresize 25µm	FEPTFE25PF2017
1 unit PTFE filter element poresize 100µm	FEPTFE100PF2017
1 unit of O-ring FKM	ORPF2017FKM

Note: Filter elements with other pore sizes on request.



Absorber model ABS 20.03

- Removal of aggressive components in flue gas
- Sacrificial materials prevent corrosion damages on gas analysers
- High deposition rate of 99,99%
- Made in Germany 

Functional description:

The absorber is designed for the **removal of aggressive components (SO₃, HF, HCL, H₂S)** from the measuring gas flow, predominantly of emission measurements. This deals with responsive gases/aerosols, which are absorbed by the filled sacrificial materials. This takes place with high efficiency. The service life of the sacrificial materials depends on the load of the measuring gas. The measuring components (O₂, CO, CO₂, CnHm, NO_x, SO₂, NH₃) are not influenced by the sacrificial materials based on experience.

Assembly:

Installation of the absorber between the flow meter and the condensate separator in front of the analyser. The absorber SUN ABS 20.03 must **be assembled vertically**. A horizontal position would guide away the gases to be absorbed, in the most unfavourable case, over the sacrificial materials without any reaction. Two spring steel clips are enclosed for the wall mounting.

Gas flow diagram:

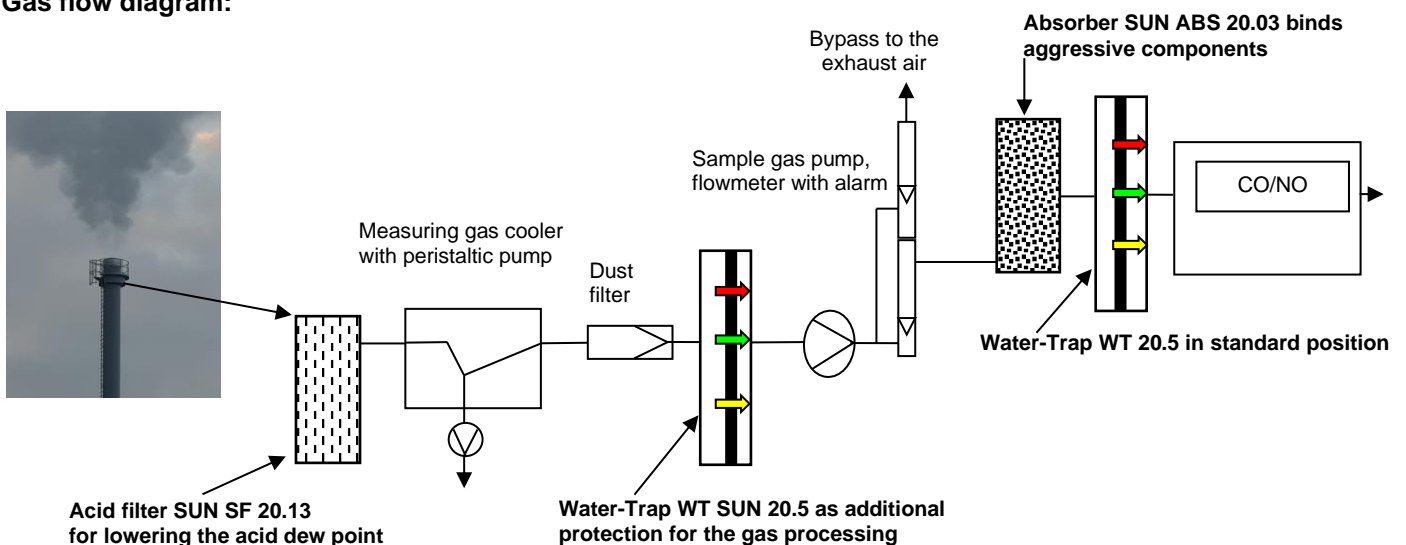

Technical specifications:

Scope of delivery: Absorber container with filling, 2 pices wall mounting clamps
 Materials used: PVDF, Duran-Glas, PP, FKM, spring steel (mounting clamps)
 Operating pressure: 0 - 500 mbar
 Gas flow: 0 - 120 l air/h

Pressure drop at 120 l air/h: approx. 10 mbar
 Operating temperature: + 5°C - + 90°C
 Housing dimensions: Diameter 50 mm, length 300 mm
 Housing volume: 150 ml
 Gas connections: GAS-IN 6/4 mm hose fitting
 GAS-OUT 6/4 mm hose fitting

Assembly: Wall mounting with assembly bracket (included in scope of delivery)
 Language operating instructions: German and English (included in the scope of delivery)
 Spanish, Italian, French, Russian upon request

Article numbers:

Article	Article number
Absorber complete, with retaining bracket and filling materials	ABS2003
Absorber stain less steel, complete, with wall monting bracket and filling materials	ABS2003E
Options:	
Crack protection for glas body (transparent)	BSABS2003
Spare parts:	
1 set refill materials for absorber ABS 20.03	OPFABS2003
1 set refill for absorber ABS 20.03E	OPFABS2003E
1 unit of O-ring FKM	ORABS2003FKM
1 piece connection cap (red) complete with screw connection and O-ring	KAPABS2003

Illustration

Absorber heavily consumed



Absorber refill materials





Absorber (ABS2003E) stainless steel model complete with mountig bracket

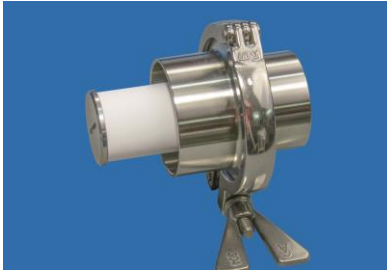



Gas sampling filter model GEF 26

- Process gas extraction for gas analyzers
- Inlying dust filter
- Less space requirement
- „Easy-Filter-Change-System“ by Tri-Clamp technique
- Self-cleaning via back purging
- Made in Germany  
- Certificates: 3.1 material certificate, ATEX 2014/34/EU



Functional description:

The gas sampling filter model GEF 26 is used for gas sampling in process gas analysis. The construction allows a small footprint. The in-process filter can be installed using various connection techniques. Various filter elements / pore sizes are available. The immersion depth of the filter element can be varied over several extensions (option). For the internal filter a dust deflector (option, item STAWGEF26) is available.

Gas flow diagram:

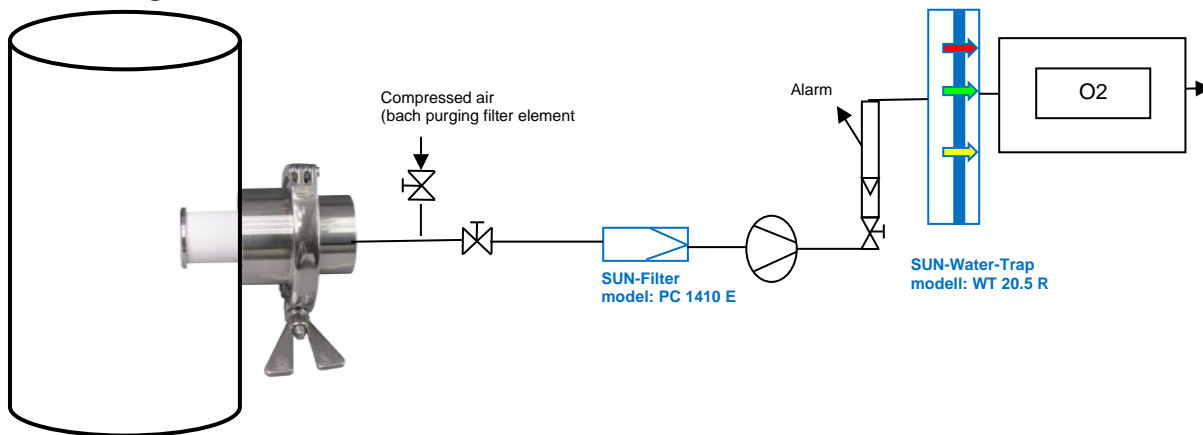



The sample gas is pre-cleaned via the gas sampling filter model GEF 26. The filter model PC1410 E supplements the filter sequence. The Water-Trap model WT 20.5R is used for fine filtration and at the same time as protection against possible condensate break-in (police filter).

Technical specifications:

Scope of delivery:	Filter housing with retaining screw for filter element, Tri-Clamp with wing nut, Tri-Clamp seal FKM (Viton), weld-in nozzle, filter elements (optional) PTFE porous or stainless steel mesh 1.4404
Materials used:	Stainless steel type 1.4301 (SS304), FKM (Viton), PTFE (filter element)
Operating pressure:	-0,5 – 6 bar
Compressed air for back purging:	1 - 6 bar
Gas flow:	0 - 1000 l airt/h

Pressure drop at 200 l air/h: ca. 10 mbar
 Dust loading: 0 - 10 mg/m³*
 Operating temperature: -20°C - +150°C
 Housing volume: 35 ml
 Effective filter area: 70 cm²
 Gas connections: ¼" NPT- inside thread, (¼" G- inside thread on request)

Housing dimensions: Diameter mounting clamp 135 mm, total length 120 mm
 Immersion depth filter element: 35 mm
 Dipping length dust deflector: 65 mm (short), 115 mm (long)
 Installation with weld-in nozzle: Weld-in nozzle DN 50, DIN 32676, Reihe B lang, diameter 60,5 mm
 (Alternative)
 Installation with circular flange plate: Circular flange plate DN 50 PN 6, material: stainless steel (1.4301), diameter 60,5 mm
 Dimensions: outside diameter 140 mm, bolt circle 110 mm, number 4, whole diameter 14 mm, material thickness 3 mm

Gas explosion proof ATEX:  II 2G Ex h IIC Gb -20°C ≤ Ta ≤ +150°C attestation EPS 19 ATEX 2 187 U
 Dust explosion proof ATEX:  II 2D Ex h IIIC Db -20°C ≤ Ta ≤ +150°C attestation EPS 19 ATEX 2 187 U
 Language operating instructions: German and English (included in the scope of delivery)
 Spanish, Italian, French, Russian upon request
 Certificates/attestations: 3.1 material quality certificate, NACE-MR0175-98, certificate of conformity ATEX 2014/34/EU

For operation in potentially explosive ambience:

The products can be used in explosive ambience of Zone 1, Zone 2, and Zone 21 und 22.
 Allowed the explosion classes IIA, IIB und IIC.

The products have no self-heating during intended operation and can be used in dependency of the maximum permissible media temperature for gases of the temperature class T6.

Article numbers:

Article	Article number
Filter housing, with retaining screw for filter element, Tri-Clamp technique with butterfly nut, sealing FKM (Viton), <u>without</u> filter element, with weld-in nozzle	GEF26
Filter housing, with retaining screw for filter element, Tri-Clamp technique with butterfly nut, sealing FKM (Viton), <u>without</u> filter element, with circular flange plate	GEF26FLPL

Filter housing with weld-in nozzle

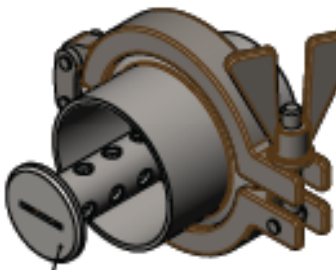

Filter housing with circular flange plate

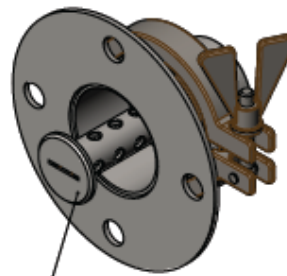

Filter elements:

Article	Article number
Filter elements made of PTFE:	
1 unit of filter element for particle filtration, Material PTFE-porous, pore size 1 µm	FEPTFE1GEF26
1 unit of filter element for particle filtration, Material PTFE-porous, pore size 10 µm	FEPTFE10GEF26
1 unit of filter element for particle filtration, Material PTFE-porous, pore size 25 µm	FEPTFE25GEF26
1 unit of filter element for particle filtration, Material PTFE-porous, pore size 50 µm	FEPTFE50GEF26
1 unit of filter element for particle filtration, Material PTFE-porous, pore size 100 µm	FEPTFE100GEF26
Filter elements made of stainless steel:	
1 unit of filter element for particle filtration, material stainless steel 14404, pore size 1 µm	FESS1GEF26
1 unit of filter element for particle filtration, material stainless steel 14404, pore size 10 µm	FESS10GEF26
1 unit of filter element for particle filtration, material stainless steel 14404, pore size 25 µm	FESS25GEF26

Options and spare parts:

Article	Article number
Dust deflector for filter element, material stainless steel (1.4301). Fits the standard length GEF26	STAWGEF26
Adapter for filter element length of 50 mm for extending the depth of filter element	ADAP50GEF26
Heating sleeve made of stainless steel (1.4301) for gas sampling filter GEF 26, 230VAC, 200 Watt, thermocouple PT100, cable length 300 mm, temperature max. 120°C	HEIMAGEF26
1 unit Tri-Clamp gasket FKM (Viton), color black	DITCGEF26FKM
1 unit Tri-Clamp gasket PTFE, color white	DITCGEF26PTFE

Options:

Adapter filter element

Item number: ADAP50GEF26



Heating sleeve

Item number: HEIMAGEF26



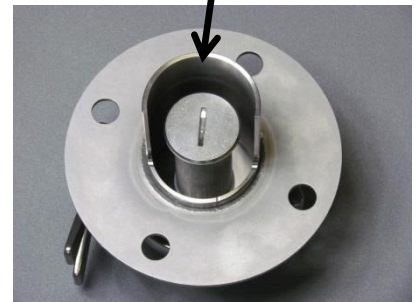

Dust deflector

Item number: STAWGEF26





Condensate-Separator model KVE in a stainless steel housing

- For the continuous separation of gas/liquid mixtures
- For collection of liquids (condensate storage vessel)
- Volume can be expanded using modular technology
- Water-Trap-Cartridge (optional) prevents condensate break-through
- Made in Germany  
- Certificates: ATEX 2014/34/EU

Functional description:

The Condensate-Separator model KVE is designed for continuous separation of gases and liquids. The measuring gas with percentage of condensate is lead into the Condensate-Separator via a gas input (GAS-IN). Due to the centrifugal force, the heavier condensate accumulates in the bottom of the vessel. This is drained via the condensate output 1 (CONDENSATE-OUT1).

For large amounts of condensate, the condensate output 2 (CONDENSATE-OUT2) can also be used. The lighter measuring gas is feed at the top of the vessel (GAS-OUT).

A Water-Trap-Cartridge (option) can be installed. With the inside semipermeable membrane, this prevents condensate breakthrough. The membrane separates gases from water, weak acids and dust. The membrane is not suitable for condensates with liquid hydrocarbons, f.e. oils and gasoline in refining process gases.

The Condensate-Separator model KVE can be used as a condensate storage vessel.

Schematic representation:

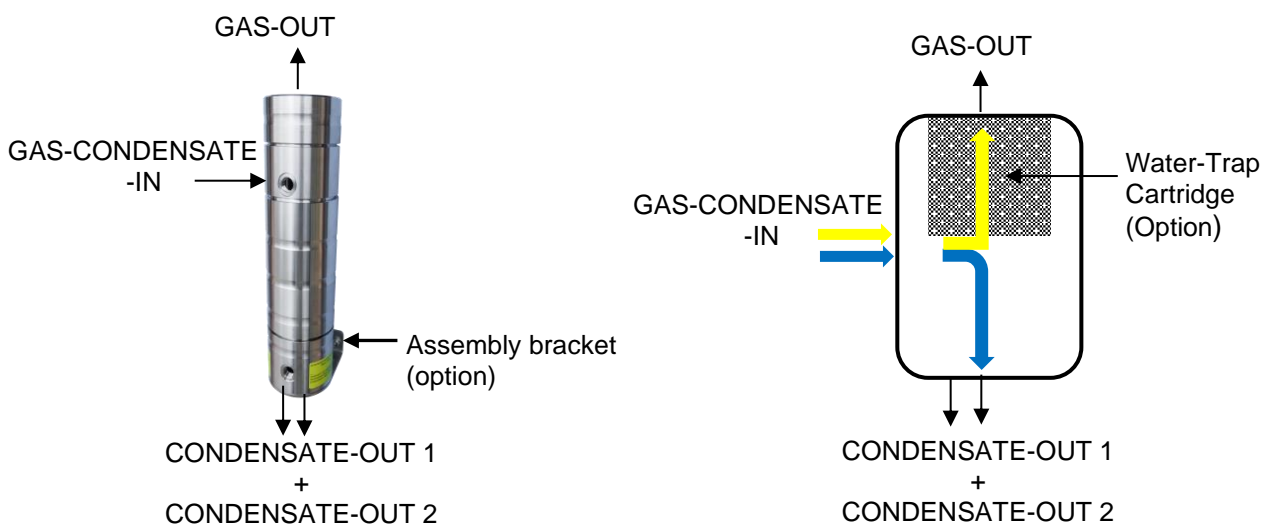

Technical specifications:

Scope of delivery: Housing, Water-Trap Cartridge (option), wall assembly bracket (option)
 Materials used: Stainless steel, type 1.4301, FKM (O-ring)
 Wall mounting bracket (option): Stainless steel type 1.4301

Operating pressure: 0 – 12 bar
 Gas flow: 0 – 10.000 l air/h

Pressure drop at 1.000 l air/h: approx. 12 mbar
 Pressure drop at 5.000 l air/h: approx. 30 mbar
 Operating temperature: + 5°C - +90°C
 Housing volume: 750 ml

Housing dimensions: Diameter 80 mm, length 300 mm
 Gas connections: GAS-IN ¼" G - inside thread
 GAS-OUT ¼" G - inside thread
 KONDENSAT-OUT 1 ¼" G - inside thread
 KONDENSAT-OUT 2 ¼" G - inside thread
 Assembly: Wall mounting with assembly bracket (option)

Gas explosion proof ATEX: ⚠ II 2G Ex h IIC Gb +5°C ≤ Ta ≤ +90°C attestation EPS 19 ATEX 2 187 U
 Dust explosion proof ATEX: ⚠ II 2D Ex h IIIC Db +5°C ≤ Ta ≤ +90°C attestation EPS 19 ATEX 2 187 U
 Language operating instructions: German and English (included in the scope of delivery)
 Spanish, Italian, French, Russian upon request
 Certificates/attestations: 3.1 material quality certificate, NACE-MR0175-98 (on request)
 certificate of conformity ATEX 2014/34/EU

For operation in potentially explosive ambience:

The products can be used in explosive ambience of Zone 1, Zone 2, Zone 21 und 22.
 Allowed the explosion classes IIA, IIB und IIC.
 The products have no self-heating during intended operation and can be used in dependency of the maximum permissible media temperature for gases of the temperature class T6.

Water-Trap Cartridge (option)

Water pressure membrane: 0 - 1 bar
 Effective filter area: 550 cm²
 Diaphragm pore size: < 0.1 µm
 Materials used: PTFE, PP, SUN-C coating
Note: The Water-Trap Cartridge is not suitable for use with aromatic hydrocarbons, e.g. oils and fuels in refinery process gases

Article numbers:

Article	Article number
Condensate-Separator, model KVE, in accordance with technical specifications	KVE
Condensate-Separator, model KVEKAWT, in accordance with technical specifications. With integrated Water-Trap-Cartridge	KVEKAWT
Options:	
1 stainless steel bracket for wall mounting	MONWIWT2048
Spare parts:	
Water-Trap-Cartridge	KAWT2048
1 O-ring FKM	OR2048FKM



Spiral for lowering temperature model SPENIV material stainless steel

- For temperature reduction of process gases
- Functional design bracket for wall mounting
- Made in Germany  
- Certificates: 3.1 material certificate, ATEX 2014/34/EU

Functional description:

The Spiral Model SPENIV is designed for continuous temperature reduction/levelling of process gases. The convective heat transfer brings the sample gas to a lower temperature level (a air blower is available as an option). Via a Water-Trap (model WT20.48, WT 20.83) the condensate can be removed. The spiral can also be switched in front of electric gas coolers (model GT5).

Schematic representation Modell SPENIV2:

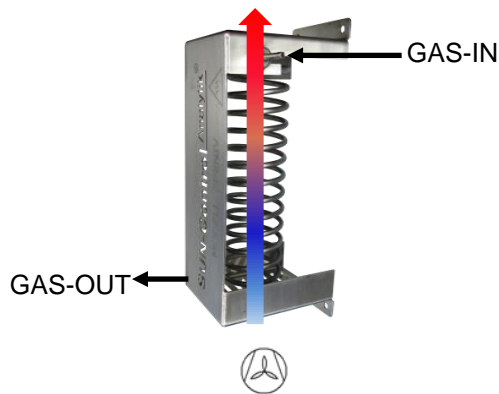

Option: Air blower
 Item number: GEBLGT565

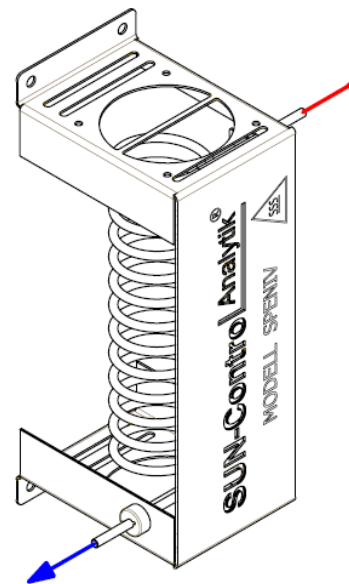

Technical specifications:

Scope of delivery: Spiral, wall assembly bracket
 Materials used: Stainless steel type 1.4571, 3.1 material certificate (option), (PTFE tube on request)
 Wall mounting bracket (option): Stainless steel type 1.4301

Operating pressure: 0 – 100 bar (higher operating pressures on request)
 Operating temperature: + 5°C to +350°C (higher temperatures on request)

Gas flow: 0 – 180 l air/h
 Pressure drop at 60 l air/h: approx. 5 mbar
 Pressure drop at 180 l air/h: approx. 15 mbar

Spiral:	Length 3 mtr., volume 60 ml, material Stainless steel type 1.4571 (option 3.1 certificate)
Temperature reduction:	approx. 30 K at 180 l air/h, approx. 60 K at 120 l air/h
Temperature reduction with airblower (GEBLGT565):	approx. 60 K at 180 l air/h, approx. 120 K at 120 l air/h
Advice:	The specified temperature reduction (GAS-IN / GAS-OUT) is dependent by the ambient temperature, Gas inlet temperature, pressure, gas composition, moisture content and other parameters
Option air blower:	IP 65, 24 V/DC 0,5 A, -20°C - +65°C. <u>Attention: Air blower <u>not</u> for hazardous area</u>
Dimensions, weight:	Width 210 mm, height 360 mm, depth 160 mm, 3 kg
Gas connections:	GAS-IN 6 mm pipe nozzle GAS-OUT 6 mm pipe nozzle
Assembly:	Wall mounting with assembly bracket (included in scope of delivery)
Gas explosion proof ATEX:	⊕ II 2G Ex h IIC Gb +5°C ≤ Ta ≤ +350°C attestation EPS 19 ATEX 2 188 U
Dust explosion proof ATEX:	⊕ II 2D Ex h IIIC Db +5°C ≤ Ta ≤ +350°C attestation EPS 19 ATEX 2 188 U
Language operating instructions:	German and English (included in the scope of delivery) Spanish, Italian, French, Russian upon request
Certificates/attestations:	3.1 material quality certificate, NACE-MR0175-98 (on request) certificate of conformity ATEX 2014/34/EU

For operation in potentially explosive ambience:

The products can be used in explosive ambience of Zone 1, Zone 2, Zone 21 und 22.

Allowed the explosion classes IIA, IIB und IIC.

The products have no self-heating during intended operation and can be used in dependency of the maximum permissible media temperature for gases of the temperature class T6.

Article numbers:

Article	Article number
Spiral for lowering temperature model SPENIV2 with preparation for installation of air blower	SPENIV2
Accessories:	
Air blower IP65 (self-assembly)	GEBLGT565
Personal prtotection grill for air blower	BSGEBLGT565



Process-Analytic-Cooler

1) Model GT5.65

- Robust construction for industrial application
- Dust and splash water protected. Degree of protection IP 65

2) Model GT5.SE

- LOW BUDGET gas cooler (IP 20) for cabinet installation

- Made in Germany



SIL ✓
prepared



Functional description:

The Process-Analytic-Cooler model GT5 is used for the safe cooling of process, sample and flue gases in gas analysis technology. The gas to be measured is reduced reliably to a pre-set temperature/dew point via an industrial heat exchanger that is 1200 mm long (spiral form with additional turbulator) made of stainless steel.

The collected condensate is separated via the Water-Acid-Trap (option).

The Water-Acid-Trap offers an additional protection against condensate breakthrough and dust deposits with the integrated membrane technology of the SUN-Control-Analytik. After the Process-Analytic-Cooler you have a dry and dust-free sample gas corresponding to dew point for your high quality gas analyser/gas sensor at your availability.

The Process-Analytic-Cooler can be used also for cooling of fluids.

Overview of advantages:

- Robust gas cooler in transmitter housing (IP 65) for industrial applications
- Fail-safe pipe heat exchanger made of high-performance stainless steel (1.4571). Suitable for combustible gases
- Service-friendly setup with quick replacement system
- With Water-Trap protection against condensate breakthrough (option)
- Ambient temperature up to +60°C possible (desert design)
- Temperature remote monitoring via built-in temperature sensor (option)
- Ideally suitable from electrochemical sensors/measuring heads to upper class analyzers

Suitable for the following applications:

- Emission measurements with fossil fuels
- Renewable energy (Hydrogen technology)
- Biogases
- Process measurement
- Heat treatments
- Cement, glass, steel, paper industries

Not suitable for the following applications:

- Official measurements such as TA-Luft and BImSchV measurements are only possible to a limited extent
- Applications with more than one heat exchanger

Technical data:

Scope of delivery:

Protective housing inside:

Heat exchanger stainless steel, Peltier cooling module, temperature regulator, Temperature indicator, temperature alarm via electrical contact
 Temperature monitoring via temperature sensor PT100 (option)

Heat sink with fan and wall mounting bracket

Water-Acid-Trap model WT2048KOB (option)

Degree of protection:

IP 65 alternative IP 20

Power supply:

24 V/DC, 5.5 A 150 VA. Connecting terminal 0.7-1.5 mm², cable gland M16

Cooling technology:

Peltier, TEC thermoelectric cooler

Heat exchanger:

Numbers 1, volume 20 ml, material stainless steel 1.4571 (HC 22, PTFE on request)

Flow rate:

0 - 250 L/h (0 – 500 L/h on request)

Operating pressure: 0 – 100 bar (higher pressures on request)
 Differential pressure: 15 mbar at 250L/h air
 Gas input temperature: +5°C - +140°C
 Input dew point: 0°C - +70°C
 Gas output dew point: Factory setting +8°C (feasible from +5°C to +15°C), dew point stability +/- 0,5°C

Max. Cooling capacity: 115 kj/h
 Ambient temperature: +5°C - +45°C (+60°C on request)
 Ready for operation: 30 minutes
 Temperature alarm: Single-pole potential-free contact. Contact load 250 VAC/ 1 A
 Temperature monitoring: Via built-in temperature sensors, the current temperature of the Analytic-Cooler can be integrated into a customer SIL loop.
 (Option) SIL 2 preparation via 1 piece 3 wire PT 100 class A, t90 12sec.

Temperature display: Analogue indicator bimetallic
 Gas connections GT5: GAS-IN 6 mm pipe nozzle, GAS-OUT 6 mm pipe nozzle
 Dimensions/Weight: Width 330 mm height 220 mm, depth 270 mm, 12 kg
 Mounting: Wall mounting/ plate via mounting bracket (included in scope of delivery)
 Approval: UL 508A, Low Voltage Limited Energy Circuits (on request)
 Assembly: Wall assembly/assembly plate
 Note: The technical data applies at +25°C ambient temperature. In the case of increasing ambient temperature a reduction in performance is to be expected.
 Water-soluble components, such as e.g. sulphur dioxide (SO₂) and nitrogen dioxide (NO₂), can be influenced by condensation.

Schematic diagram:



The Process-Analytic-Cooler drains the condensate via external components, e.g. stainless steel Water-Trap Model WT 20.48 KOBEGT5 (option). This constellation is used in the monitoring of hydrogen and oxygen during electrolysis (see application examples).

Note: Connection (dashed line) from the Analytic-Cooler (GT5) to the Water-Trap (WT2048BOBEGT5) is supplied by the customer (not included in the scope of delivery).

Technical data Water-Trap model WT2048KOBEGT5 (option):

Scope of delivery: Housing with integrated cartridge, wall assembly bracket
 Water pressure membrane: 0 - 1 bar
 Operating pressure for gas: 0 - 100 bar
 Diaphragm pore size: < 0.1 µm
 Effective filter area: 550 cm²

Operating temperature: 0°C - +90°C
 Housing volume: 200 ml
 Materials used: Stainless steel type 1.4571 (SS316Ti), PTFE, PP, FKM
 Wall mounting bracket: Stainless steel type 1.4301
 Dimensions: Diameter 80 mm, length 100 mm
 Gas connections: GAS-IN 1/4"G-inside thread
 GAS-OUT 1/4"G-inside thread
 KONDENSAT-OUT 1/4"G-inside thread



Diameter 80 mm
 length 105 mm
 Deep 100 mm

Assembly: Wall mounting with assembly bracket
 Gas explosion proof ATEX:  II 2G Ex h IIC Gb 0°C ≤ Ta ≤ +90°C
 Certificates/attestations: certificate of conformity ATEX 2014/34/EU, Helium leakage test attestation

SUNOX100-process

Oil and grease-free products for applications with 100% oxygen (on request)

Article numbers:

protection of utility patents DE 20 2017 103 071

Article	Article number
Process-Analytic-Cooler IP 65 model GT5.65 according to technical data	GT565
Process-Analytic-Cooler IP 20 model GT5.SE according to technical data	GT5SE
Water-Trap model WT 20.48 KOBE material stainless steel, with stainless steel assembly bracket for wall mounting	WT2048KOBEGT5

Options:

Article	Article number
Temperature monitoring via 1 piece temperature sensor PT100 (SIL 2 preparation)	SIL2GT5
Material certificate 3.1 for heat exchanger	MATZGT5

Spare parts:

Article	Article number
Air blower IP65	GEBLGT5
Heat exchanger made of stainless steel 1.4571 with cooling dome	WAETGT5
Temperature regulator	TR2EGT5
Temperature analogue indicator	TAZGT5
Cartridge Water-Acid-Trap	KAWT2048
O-ring for Water-Acid-Trap, FKM (color green)	OR2048FKM

Dimensions Analytic-Cooler model GT565 (IP 65), model GT5SE (IP 20):

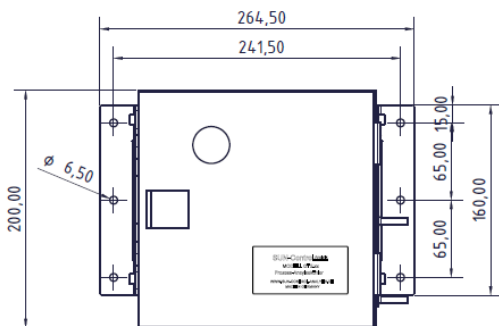

Dimensions Water-Trap model WT2048KOBEGT5:

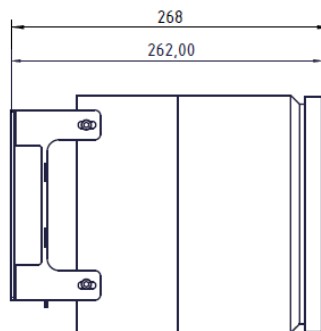

Diameter 80 mm
 length 105 mm
 Deep 100 mm



Process-Analytic-Cooler model GT5.Ex

- Gas-Explosion proof design for zone 1
- Dust-Explosion proof design for zone 21
- Robust Transmitter design degree of protection IP 66
- Low space requirement
- Easy to maintain construction with Quick-Change-System
- Effective industrial heat exchanger with 1200 mm length
- Temperature monitoring with alerting system
- Water-Trap with protective function (option)
- Made in Germany



SIL ✓
prepared



Unique features:

- Gas and dust explosion proof design (Ex d)
- Temperature class T6
- Degree of protection IP 66 for outdoor installation
- Ambient temperature -20 ° C to +50 ° C
- No running compressor components
- No motor protection switch necessary
- Temperature remote monitoring (option)

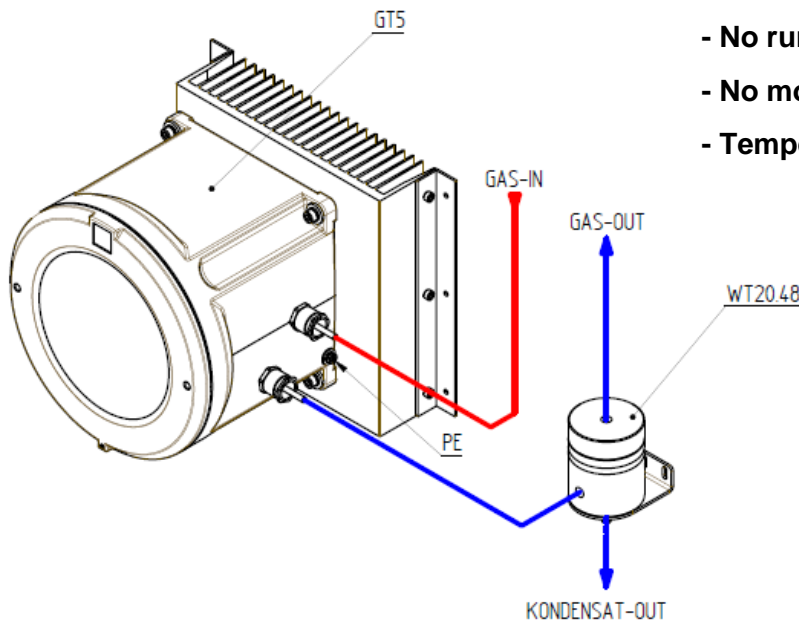

Functional description:

The Process-Analytic-Cooler model GT5.Ex is used for the safe cooling of process, sample and flue gases in gas analysis technology. The gas to be measured is reduced reliably to a pre-set temperature/dew point via an industrial heat exchanger that is 1200 mm long (spiral form with additional turbulator) made of stainless steel.

The collected condensate is separated via the Water-Trap (option).

The Water-Trap offers an additional protection against condensate breakthrough and dust deposits with the integrated membrane technology of the SUN-Control-Analytik. After the Process-Analytic-Cooler you have a dry and dust-free sample gas corresponding to dew point for your high quality gas analyser/gas sensor at your availability.





The Process-Analytic-Cooler can be used also for cooling of fluids.

Technical data:

The model **GT5.Ex** is approved for use in potentially explosive atmospheres of **Zones 1 and 21** and comply with the following standards and regulations: IEC/EN 60079-0, 60079-1, 60079-31

EPS 17 ATEX 1 072





IECEX EPS 17.0036

Gas:  II 2G Ex db IIC T4 Gb (Tamb +60°C)  II 2G Ex db IIC T6 Gb (Tamb +40°C) Dust:  II 2D Ex tb IIIC T130° Db (Tamb +60°C)  II 2D Ex tb IIIC T80° Db (Tamb +40°C)	Gas: Ex db IIC T4 Gb (Tamb +60°C) Ex db IIC T6 Gb (Tamb +40°C) Dust: Ex tb IIIC T130° Db (Tamb +60°C) Ex tb IIIC T80° Db (Tamb +40°C)
--	--

The model **GT5.Ex.Z2** is approved for use in potentially explosive atmospheres of **Zones 2 and 22** and comply with the following standards and regulations: IEC/EN 60079-0, 60079-1, 60079-31

EPS 17 ATEX 1 072

IECEX EPS 17.0036

Gas:  II 3G Ex db IIC T4 Gc (Tamb +60°C)  II 3G Ex db IIC T6 Gc (Tamb +40°C) Dust:  II 3D Ex tc IIIC T130° Dc (Tamb +60°C)  II 3D Ex tc IIIC T80° Dc (Tamb +40°C)	Gas: Ex db IIC T4 Gc (Tamb +60°C) Ex db IIC T6 Gc (Tamb +40°C) Dust: Ex tb IIIC T130° Dc (Tamb +60°C) Ex tb IIIC T80° Dc (Tamb +40°C)
--	--

Scope of delivery:	<u>Protective housing inside:</u> Heat exchanger stainless steel, Peltier cooling module, temperature regulator, controller Temperature indicator, temperature alarm via electrical contact Temperature monitoring via temperature sensor PT100 (Option) <u>Heat sink</u> with wall mounting bracket <u>Water-Acid-Trap</u> with assembly bracket for wall mounting (option)
--------------------	---

Degree of protection: Power supply: Cooling technology: Heat exchanger: Flow rate: Operating pressure: Differential pressure:	IP 66 (dust protection/water hose-proof) 85 V AC bis 264 V/AC, 150 VA, 24 V/DC Connecting terminal 0.7-1.5 mm ² , 1 x M20 Ex Peltier, TEC thermoelectric cooler Numbers 1, volume 20 ml, material stainless steel 1.4571 (HC 22 on request) 0 - 180 L/h h (0 - 500 L/h on request) 0 - 12 bar 15 mbar at 180 L/h air
Gas input temperature: Input dew point: Gas output dew point:	+5°C - +100°C C (+5°C - +150°C on request) max. +70°C Factory setting +8°C (feasible from +5°C - +15°C), Dew point stability +/- 0,5°C with Delta-T cooling see diagram
Max. Cooling capacity: Ambient temperature:	94 kJ/h -20°C - +50°C (higher ambient temperatures on request)

Ready for operation: Temperature alarm: Temperature monitoring: (Option)	30 minutes Single-pole potential-free contact. Contact load 250 VAC/ 1 A Via built-in temperature sensors, the current temperature of the Analytic-Cooler can be integrated into a customer SIL loop. SIL 2 preparation via 1 piece 3 wire PT 100 class A, t90 12sec.
---	--

Temperature display: Gas hook up GT5EX: Dimensions/weight: Mounting: Approval:	Analogue indicator bimetallic GAS-IN 6 mm pipe nozzle, GAS-OUT 6 mm pipe nozzle Width 360 mm, height 300 mm, depth 320 mm, 28 kg Wall mounting/ plate via mounting bracket (included in scope of delivery) UL 508A, Low Voltage Limited Energy Circuits (on request)
--	--

Note: The technical data applies at +25°C ambient temperature. In the case of increasing ambient temperature a reduction in performance is to be expected. Water-soluble components, such as e.g. sulphur dioxide (SO₂) and nitrogen dioxide (NO₂), can be influenced by condensation.

Gas output dew point:

Ambient temperature	Gas output dew point	
-20,0	-20,0	Cooling deactivated
-15,0	-15,0	
-10,0	-10,0	
-5,0	-5,0	
0,0	0,0	
+5,0	+5,0	
+10,0	+8,0	Cooling activated
+15,0	+8,0	
+20,0	+8,0	
+25,0	+8,0	
+30,0	+8,0	
+35,0	+8,0	
+40,0	+10,0	Delta-T cooling
+45,0	+15,0	
+50,0	+20,0	

In the Delta-T function, the cooler operates at maximum cooling capacity and remains with a delta-T > 30 K to ambient temperature, the coldest place in the gas conditioning, "The coolest part in your system"

Schematic diagram:

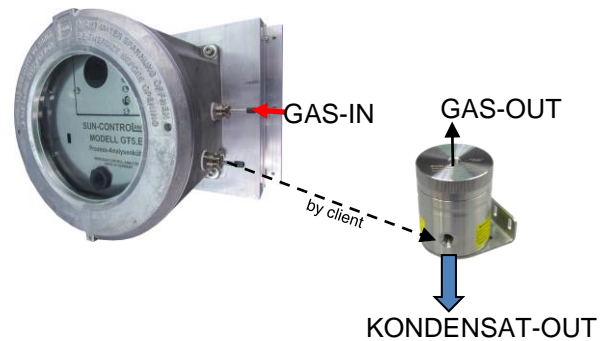
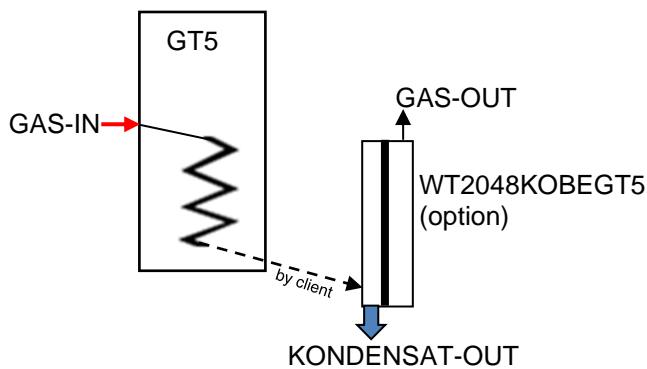

The Process-Analytic-Cooler drains the condensate via external components, e.g. stainless steel Water-Trap Model WT 20.48 KOBEGT5 (option). This constellation is used in the monitoring of hydrogen and oxygen during electrolysis (see application examples).

Note: Connection (dashed line) from the Analytic-Cooler (GT5) to the Water-Trap (WT2048BOBEGT5) is supplied by the customer (not included in the scope of delivery).

Technical data Water-Trap model WT2048KOBEGT5 (option):

Scope of delivery: Housing with integrated cartridge, wall assembly bracket
 Water pressure membrane: 0 - 1 bar
 Operating pressure for gas: 0 - 100 bar
 Diaphragm pore size: < 0.1 µm
 Effective filter area: 550 cm²

Operating temperature: 0°C - +90°C
 Housing volume: 200 ml
 Materials used: Stainless steel type 1.4571 (SS316Ti), PTFE, PP, FKM
 Wall mounting bracket: Stainless steel type 1.4301
 Dimensions: Diameter 80 mm, length 100 mm
 Gas connections: GAS-IN 1/4"G-inside thread
 GAS-OUT 1/4"G-inside thread
 KONDENSAT-OUT 1/4"G-inside thread



Diameter 80 mm
 length 105 mm
 Deep 100 mm

SUNOX100-process

Oil and grease-free products for applications with 100% oxygen (on request)

Article numbers:

protection of utility patents DE 20 2017 103 071

Article	Article number
Process-Analytic-Cooler, model GT5.Ex, for use in potentially explosive atmospheres of Zones 1 and 21	GT5EX
Process-Analytic-Cooler, model GT5.Ex.Z2, for use in potentially explosive atmospheres of Zones 2 and 22	GT5EXZ2
Water-Trap model WT 20.48 KOBEGT5 material stainless steel, with stainless steel assembly bracket for wall mounting	WT2048KOBEGT5

Options:

Article	Article number
Temperature monitoring via 1 piece temperature sensor PT100 (SIL 2 preparation)	SIL2GT5
Material certificate 3.1 for heat exchanger	MATZGT5

Spare parts:

Article	Article number
Power supply	NTGT5EX
Heat exchanger made of stainless steel 1.4571 with cooling dome	WAETGT5EX
Temperature regulator	TR2EGT5EX
Temperature analogue indicator	TAZGT5
Cartridge Water-Trap	KAWT2048
O-ring for Water-Trap FKM, colour green	OR2048FKM
O-ring for Ex-d housing	ORGEHGT5EX

Dimensions Process-Analytic-Cooler model GT5.Ex:

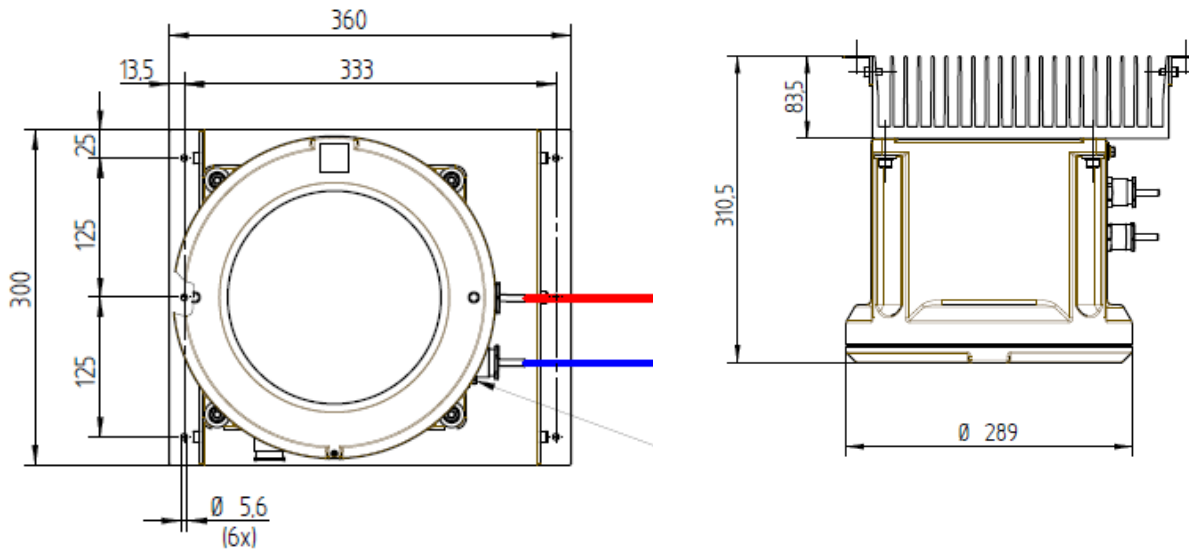

Dimensions Water-Trap model WT2048KOBEGT5:



Diameter 80 mm
 length 105 mm
 Deep 100 mm

General information - Example of gas flow diagrams

Sample application 1: CO/O₂/NO-flue gas analysis on fossil fuel boiler

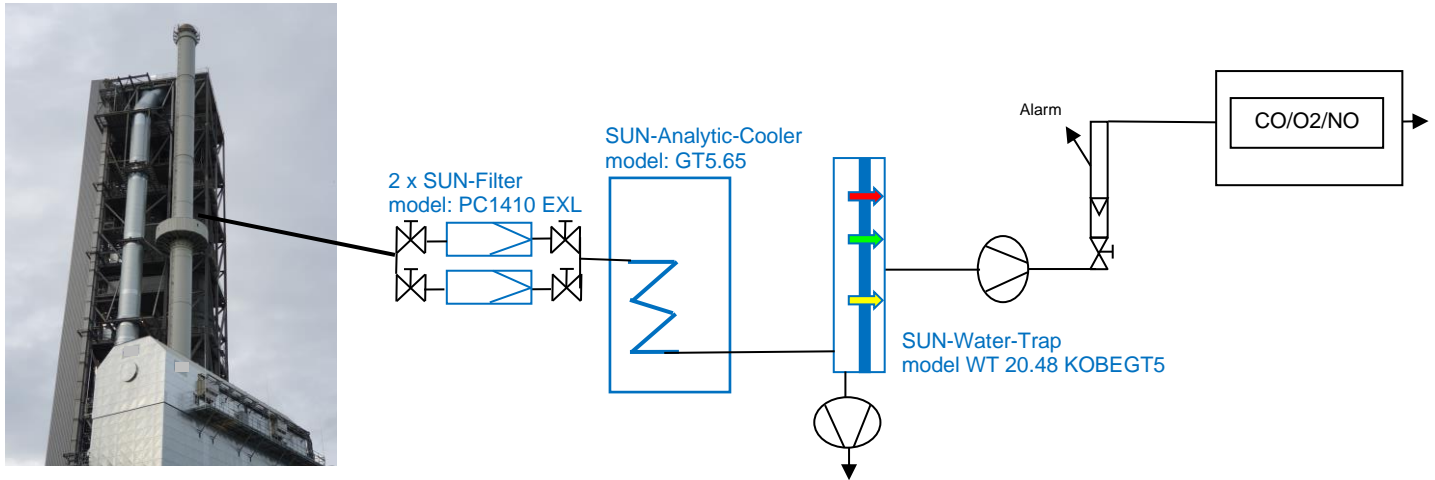

Short description: The sample gas is pre-cleaned via the two particle filters (2 x model PC1410 EXL). The parallel connection allows service-friendly maintenance without interrupting the operation measurement. The Process-Analytic-Cooler (model GT5.65) cools down the sample gas. The formed condensate is separated in the Water-Trap and discharged via a peristaltic pump. The Water-Trap model WT 20.48 KOBEGT5 with the built-in SUN-Control-Analytic-Membrane[®] protects the high-quality analyzer from condensate breakthrough and fine dust (Police filter).

Diagram explanation:
 Blue marking = SUN-product



SUN-Particle filter
 SUN-Filter element
 SUN-Assembly bracket

Article number: PC1410EXL
 Article number: FECPC1410XL
 Article number: MONWIPC1410



SUN-Analytic-Cooler

Article number: GT565



SUN-Water-Trap

Article number: WT2048KOBEGT5



Black marking = supplied by customer side



Valve

Gas-supply pump



Peristaltic-pump



Alarm



Rotameter with alarm

Gas Analyser

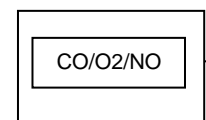

Sample application 2: CH₄/CO₂/O₂ /O₂-fermenter monitoring

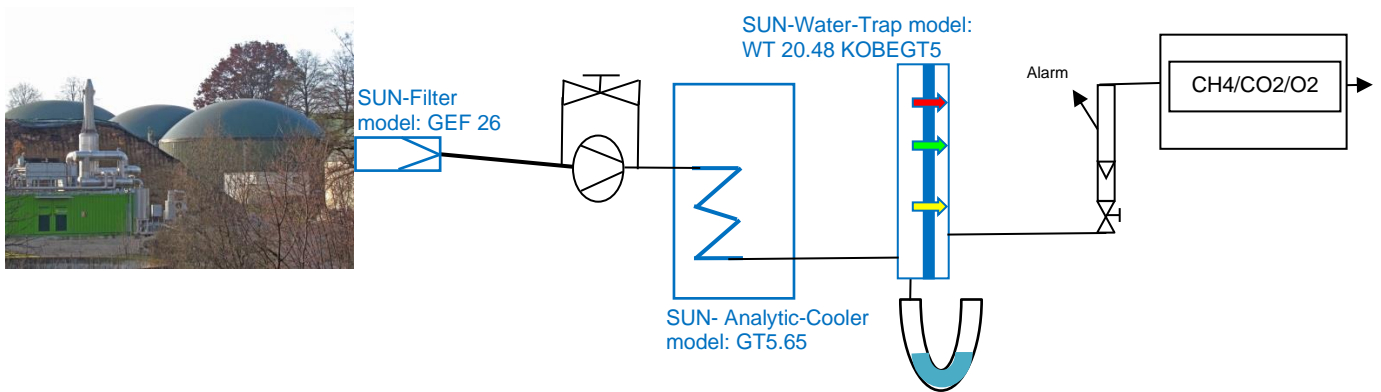

Short description: The sample gas is pre-cleaned via the gas sampling filter (model GEF 26). The Process-Analytic-Cooler (model GT5.65) cools down the sample gas. The formed condensate is separated in the Water-Trap and discharged via a syphon u pipe system. The Water-Trap model WT 20.48 KOBEGT5 with the built-in SUN-Control-Analytic-Membrane[®] protects the high-quality analyzer from condensate breakthrough and fine dust (Police filter).

Diagram explanation:
 Blue marking = SUN-product



SUN-Sampling filter
 SUN-Filter element

Article number: GEF26
 Article number: FEPTFE10GEF26



SUN-Analytic-Cooler

Article number: GT565



SUN-Water-Trap

Article number: WT2048KOBEGT5



Black marking = supplied by customer side

Gas-supply pump



Syphon u pipe system



Alarm



Rotameter with alarm

Gas Analyser

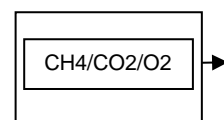

Sample application 3: O2-inertization measurement in a coal mill

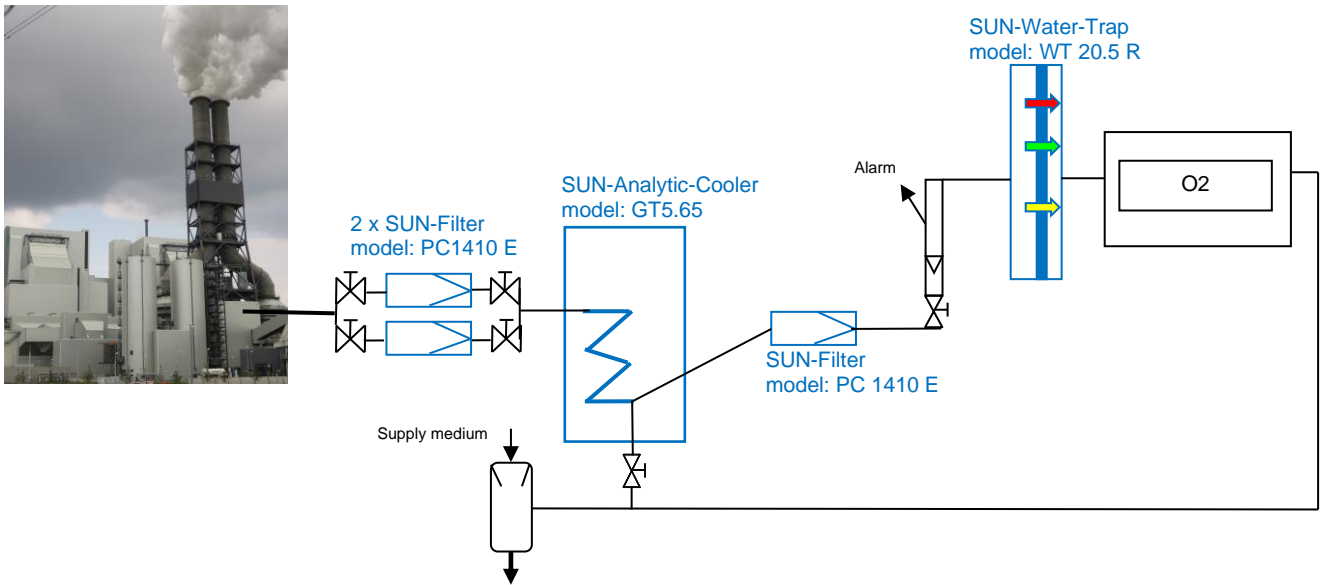

Short description: The sample gas is pre-cleaned via the particle filter (2 x model PC1410 E). The Process-Analytic-Cooler (model GT5.65) cools down the sample gas. The formed condensate is discharged via ejector (suction jet pump). The particle filter (model PC1410 E) adds the dust filter cascade. The Water-Trap (model WT 20.5 R) is used for extra fine filtering is used for extra fine filtration and at the same time as protection against condensate breakthrough (Police filter).

Diagram explanation:
Blue marking = SUN-product



SUN-Particle filter
SUN-Filter element
SUN-Assembly bracket

Article number: PC1410E
Article number: FECPC1410
Article number: MONWIPC1410



SUN-Analytic-Cooler

Article number: GT565



SUN-Water-Trap

Article number: WT205R



Black marking = supplied by customer side

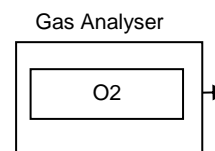
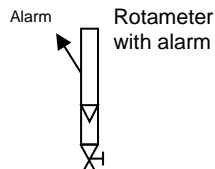
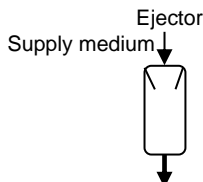

Sample application 4: CnHm/O2-process gas monitoring at LNG extraction

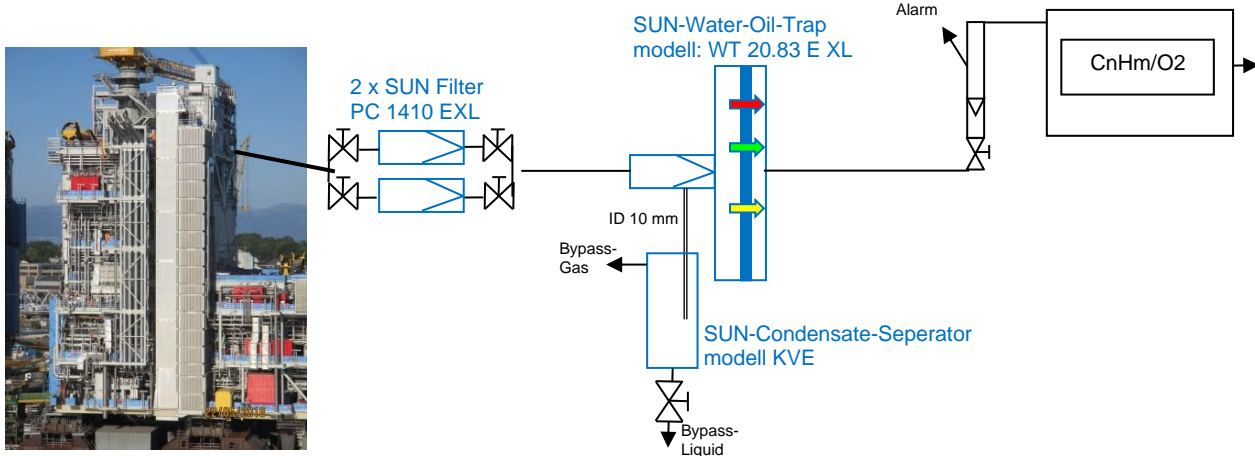

Short description: The measuring gas is pre-cleaned via the two filters (2 x model PC1410 E XL). The parallel connection allows service-friendly maintenance without interrupting the operating measurement. Condensate is deposited via the Water-Oil-Trap (model WT 20.83 E XL). The membrane system of the Water-Oil-Trap is used for fine filtration and at the same time as protection against condensate breakthrough (police filter). For larger quantities of oil in the measuring gas, it is recommended to install a Condensate-Separator (separator function) in the bypass. This prevents an sooting of the pipe due to oil residues. A short pipe connection with a large inner diameter (at least 10 mm) shall be used between the Water-Oil-Trap and the Condensate-Separator.

Diagram explanation:
Blue marking = SUN-product



SUN-Particle filter
SUN-Filter element
SUN-Assembly bracket

Article number: PC1410EXL
Article number: FECPC1410XL
Article number: MONWIPC1410

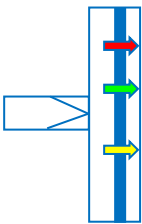

SUN-Water-Oil-Trap

Article number: WT2083EXL



SUN-Condensate-Separator Article number: KVE



Black marking = supplied by customer side



Valve

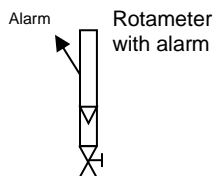

Alarm
Rotameter with alarm

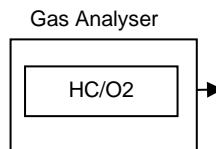

Gas Analyser

HC/O2

Sample application 5: O₂-monitoring at exhaust air flow of a paint line (explosion protection LEL)

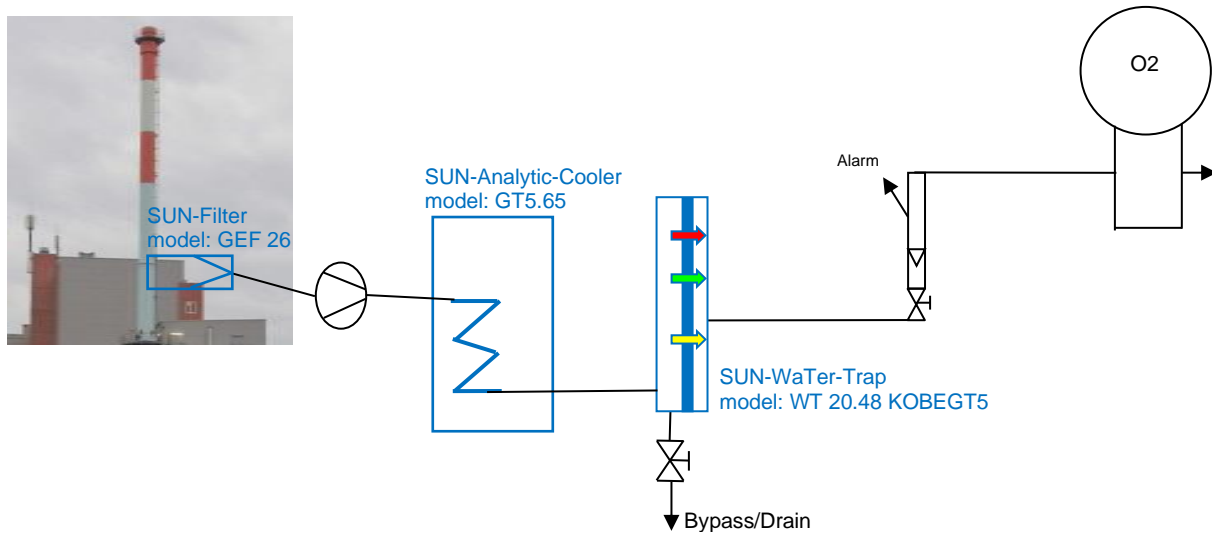

Short description: The sample gas is pre-cleaned via the gas sampling filter (model GEF 26). The Process-Analytic-Cooler (model GT5.SE) cools down the sample gas. The formed condensate is separated in the Water-Trap and discharged via manual valve. The Water-Trap model WT 20.48 KOBEGT5 with the built-in SUN-Control-Analytic-Membrane® protects the high-quality analyzer from condensate breakthrough and fine dust (Police filter).

Diagram explanation:
 Blue marking = SUN-product



SUN-Sample filter
 Filter element

Article number: GEF26
 Article number: FEPTFE10GEF26



SUN-Analytic-Cooler

Article number: GT565



SUN-Water-Trap

Article number: WT2048KOBEGT5



Black marking = supplied by customer side



Valve

Gas-supply pump

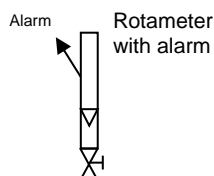

Alarm
 Rotameter
 with alarm

Gas-sensor/transmitter

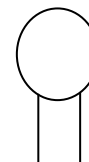

Sample application 6: H₂/O₂- monitoring of electrolysis for hydrogen production

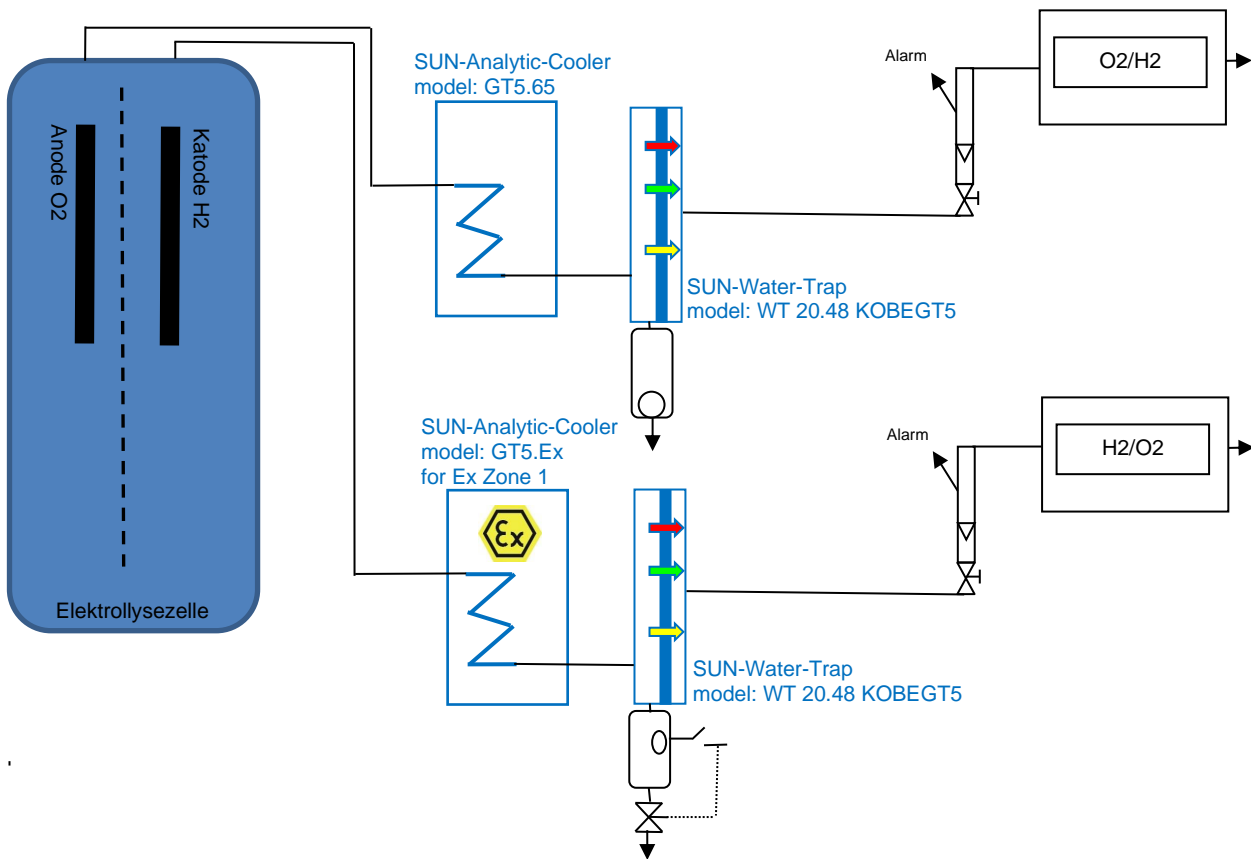

Short description: Safety-related operational measurement of oxygen (O₂) and hydrogen (H₂) on electrolyzers for the production of hydrogen. In the course of climate change, the production of regenerative hydrogen, so-called green hydrogen, is increasingly being used. The product gases are monitored for gas quality and contamination by an extractive gas analysis. The Process-Analytic-Cooler (model GT5.65) cools down the electrode sample gas. The formed condensate is separated in the Water-Trap and discharged via an automatic condensate drain. The Water-Trap model WT 20.48 KOBEGT5 with the built-in SUN-Control-Analytic-Membrane[®] protects the high-quality analyzer from condensate breakthrough and fine dust (Police filter).

The gas flow is monitored by a variable area flow meter with regulating valve. Optical and electrical alarms are standard. The analyzer converts the required gas concentrations into an analog or digital signal, which is processed further as a control, regulation and alarm signal.

Diagram explanation:
 Blue marking = SUN-product



SUN-Analytic-Cooler

Article number: GT565





SUN-Water-Trap

Article number: WT2048KOBEGT5



Black marking = supplied by customer side

Automatic condensate drain

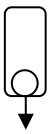

Alarm



Rotameter with alarm

Condensate vessel with float switch

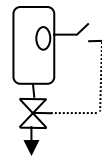

Gas Analyser

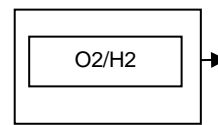

The Process-Analytic-Cooler model GT5.EX is available as an alternative for installation in potentially explosive areas.



IECEX EPS 17.0036

- Gas: Ex db IIC T4 Gb (Tamb +60°C)
- Ex db IIC T6 Gb (Tamb +40°C)
- Staub: Ex tb IIIC T130° Db (Tamb +60°C)
- Ex tb IIIC T80° Db (Tamb +40°C)



EU - Baumusterprüfbescheinigung

Sample application 7: CH₄ monitoring at drilling site. With protection function against high process pressure

System in normal operation:

Gases pass through the Water-Oil-Trap.
 Condensate is discharged via the bypass

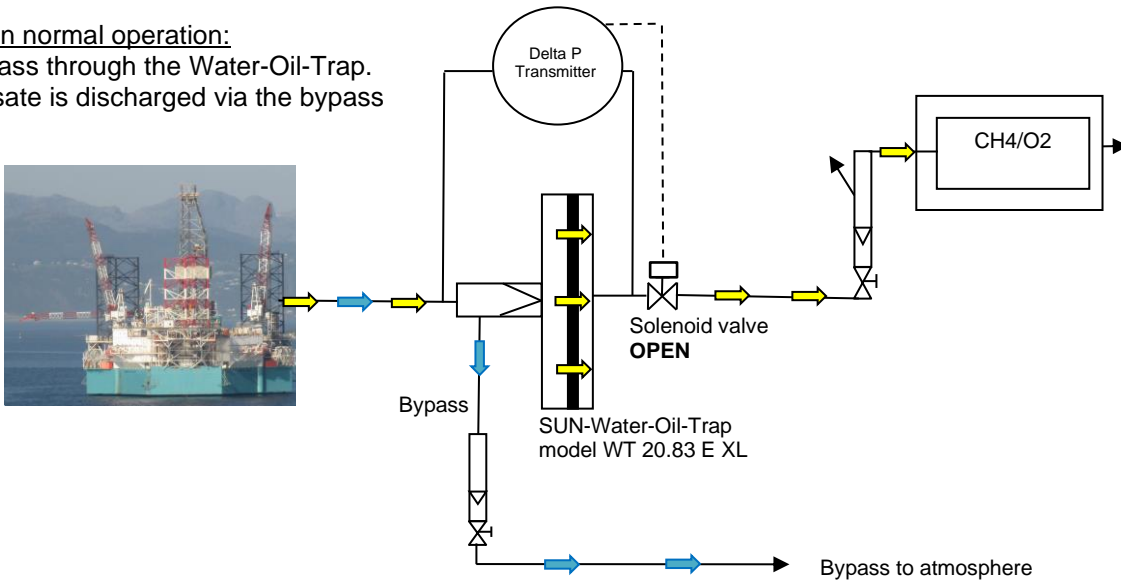

Short description: When drilling for mineral resources such as ore, precious metals, oil and gas, unexpectedly hazardous gas concentrations may occur. Hazardous areas are monitored for combustible gases and inerted or evacuated as necessary. The monitoring is done by high quality analyzers, which require a reliable gas sample handling system. In this case, the Water-Oil-Trap model WT 20.83 E XL with built-in coalescence filter and the proven double diaphragm system is used. Condensate is discharged via a bypass.

If the drill head comes across large amounts of groundwater (surge water) or oils, there is a risk that the bypass will not be able to drain the large amount of condensate quickly enough. The back pressure created in the bypass can overload the maximum allowable differential pressure of the Water-Oil-Trap membrane system. This would result in condensate breakthrough and damage to the analyzer. To prevent this, the customer should install a differential pressure measurement with shut-off. For this purpose, a transmitter is used to measure the differential pressure across the membrane of the model WT 20.83 E XL. If the delta P is too high, a downstream solenoid valve is activated which interrupts the gas flow. After the failure has been eliminated, the measurement can be continued.

Plant in the event of a fault (100% surge water):

The bypass cannot drain off the large amount of liquid
 the large amount of liquid fast enough

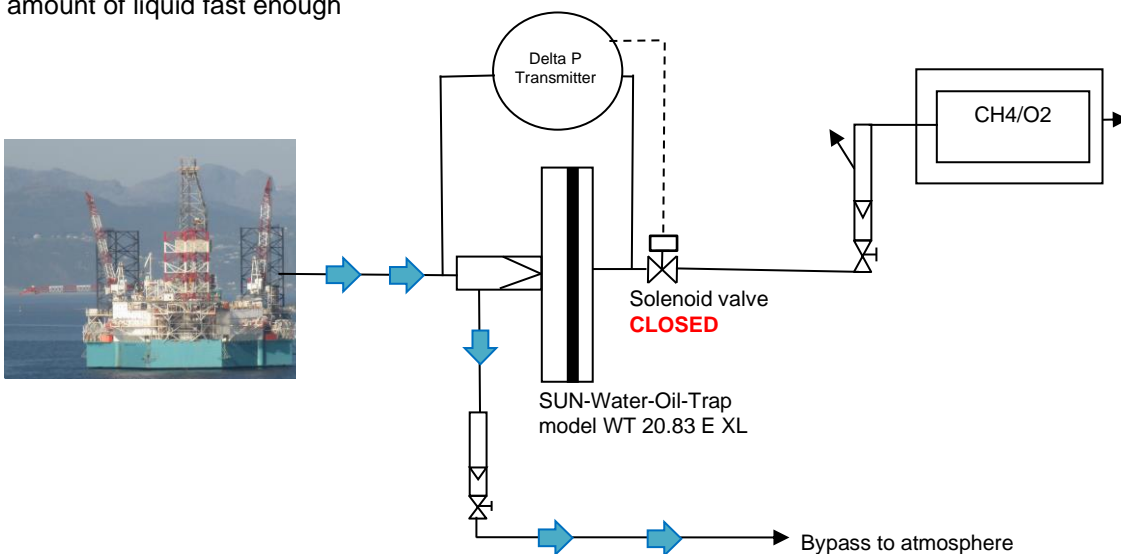

Sample application 8: Purge air monitoring of Ex-p systems

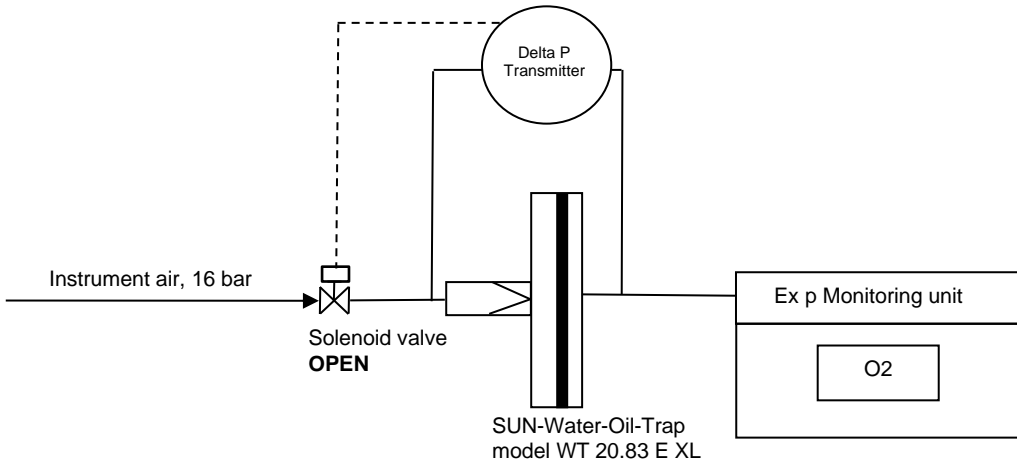

Short description: Analyzers are often used with an Ex-p monitoring unit in hazardous areas. For this purpose, the devices are purged with instrument air or nitrogen. In the event of a malfunction, this purge air can carry water in liquid form (condensate), which causes major damage to the equipment. This is where the Water-Oil-Trap model WT 20.83 E XL comes in with its built-in coalescence filter and proven double diaphragm system. Accumulating liquid is retained by the membrane system. A differential pressure switch registers the rising differential pressure and shuts off the gas flow via an upstream solenoid valve. After the fault has been rectified, the measurement can be continued.

Note Bypass, condensate drain

In principle, the bypass should be operated without pressure and without counterpressure. When discharging liquids/condensates, the following points must be observed as a matter of urgency:

- Ensure free condensate drainage via a constant slope

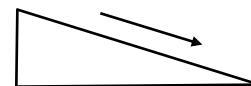

- Avoid pipe turns, danger of "water pocket" formation



- Minimum **inner** diameter of condensate drain/bypass **10 mm**



- Drain condensate immediately. Avoid condensate build-up in the product.

- Keep bypass as short as possible, avoid back pressure



General information - Water-Traps

Information about O-rings:

Abbreviated designation:	Chemical name:
FKM	Fluororubber (e.g. Viton, Tecnoflon)
PTFE	Polytetrafluoroethylene (e.g. Teflon, Hostaflon)
PFA	Poly[tetrafluoroethylene perfluoro (alkoxyvinyl ether) (e.g. Teflon®PFA)
EPDM	Ethylene propylene diene rubber (e.g. Buna EP, Vistalon)
FFKM	Perfluor rubber (e.g. Kalrez, Chemraz, Perlast)

Note: PTFE O-rings for single use only

Medium	Max. pressure in bar	Test duration in h
Acetone 50% / residual water	1.5	72
Acetone 80% / residual water	1.5	72
Fuel super (petrol station) 50% / residual water	0.5	12
Benzene 50% / residual water	1.5	72
Bromoform 80% / residual water	1.5	72
Chlorobenzene 30% / residual water	1.2	48
Cyclohexane 50% / residual water	1.2	48
Diethylene ether 10% / residual water	0.7	48
Acetic acid 80% / residual water	1.5	72
Ethanol 50% / residual water	1.5	72
Ethanol 80% / residual water	1.5	72
Heptane 25% / residual water	1.2	72
Methanol 50% / residual water	1.5	72
Methanol 80% / residual water	1.5	72
Petroleum 50% / residual water	1.5	72
Propane 2 ol 30% residual water	0.7	48
Propane 1 ol 80% / residual water	1.5	72
Hydrochloric acid 30% / residual water	1.5	72
Carbon disulphide 60% / residual water	1.5	72
Sulphuric acid 100%	1.5	72
Turpentine oil 30% / residual water	1.5	72
Carbon tetrachloride 50% / residual water	1.5	72
Toluene 50% / residual water	1.5	72
Water	2.0	250
Xylene 50% / residual water	1.5	72
Oil 10 W 40	0.3	72 (only WT 20.82, WT 20.83 and WT 30.5)
Gasoline ROZ 95	0,2	72 (only WT 20.82, WT 20.83 and WT 30.5)
<u>Other liquid hydrocarbons on request</u>		

The table is valid for 20°C ambient temperature. All the values were determined, deviations are possible. If you have other applications, we would be happy to test them in our application laboratory for breakdowns and max. pressure of liquids

Quality assurance with functional control

The Water-Traps will be filled with water and exposed to pressure for 24 hours before delivery. This test contributes to the quality assurance.

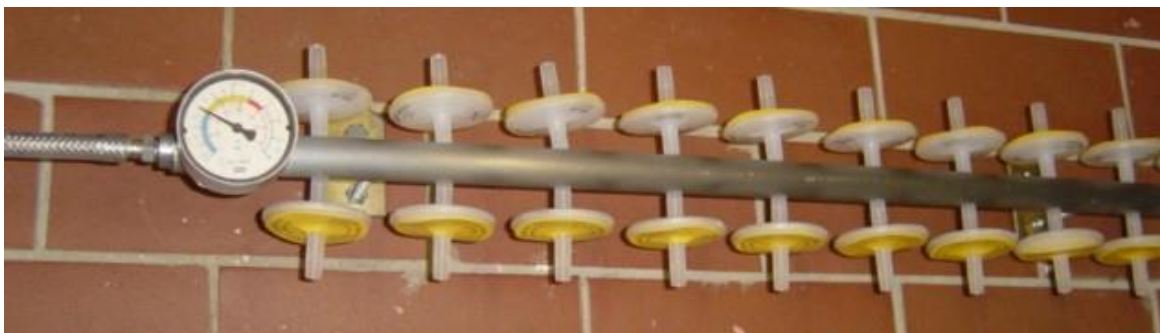

Dual Membrane System® of the Water-Oil-Trap

The Dual-Membrane-System® of the Water-Oil-Traps is a novel membrane system. Condensates such as water, acid, alkali and liquid hydrocarbons, for example, oils and gasolines in refinery process gases are retained. The design is subject to a legal protection of registered designs (registered number 20 2016 100 476)

Utility patents of SUN-Control-Analytik GmbH



„All from on hand! Made in Germany

- Certified manufacturing
- Assembly in our house
- Quality assurance system by external division
- Precise delivery through a modern logistics centre



Installation examples of SUN-Control-Analytik products



Water-Oil-Trap model WT2083EXL



Coalescence filter model PC1410E



Installation examples of SUN-Control-Analytik products

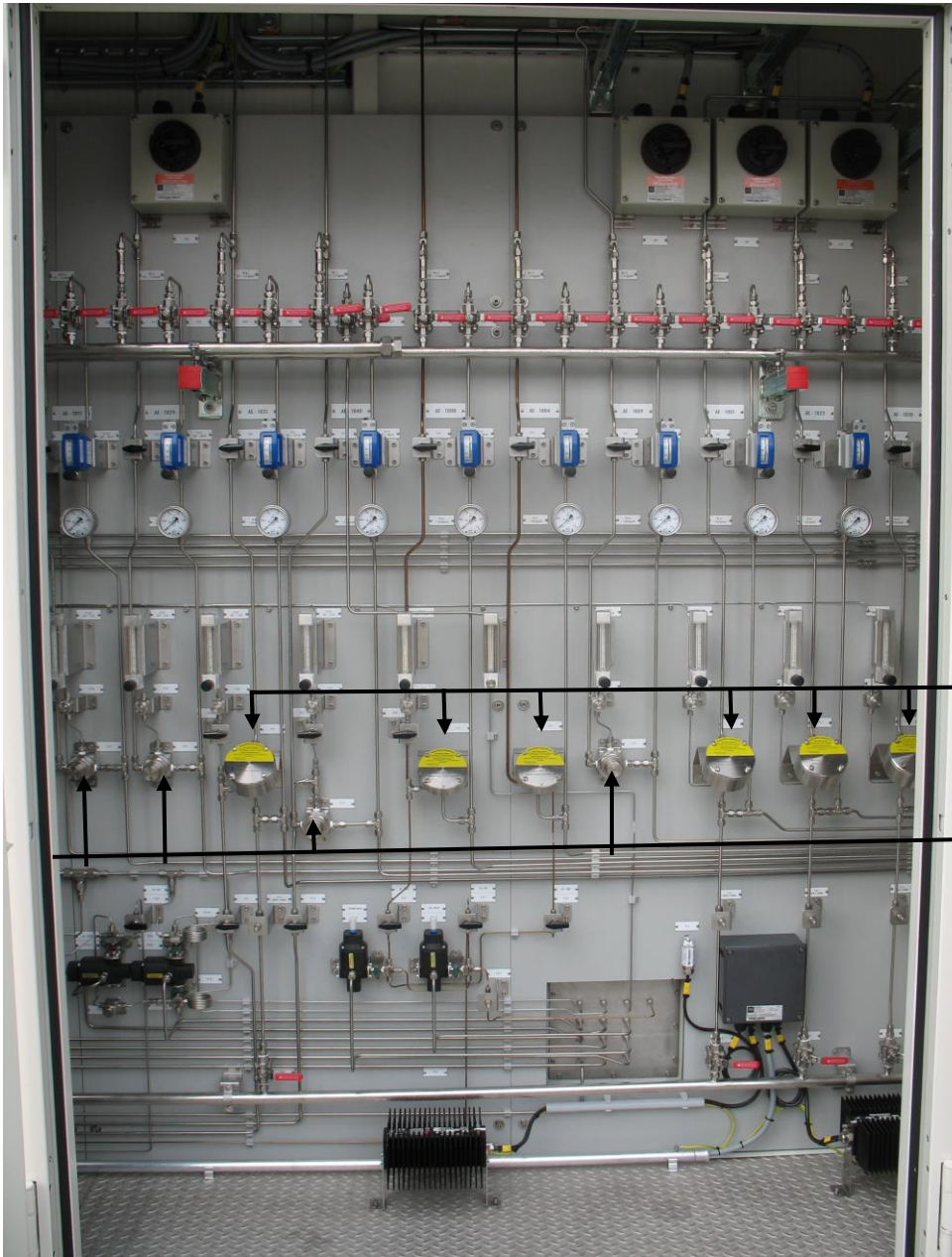

6 units of Water-Oil-Traps
model WT2083EXL

4 units of particle filter
Model PC1410E



5 units of Water-Oil-Trap
model WT2082E

Installation examples of SUN-Control-Analytik products



6 units Water-Oil-Trap
modell 2083EXL

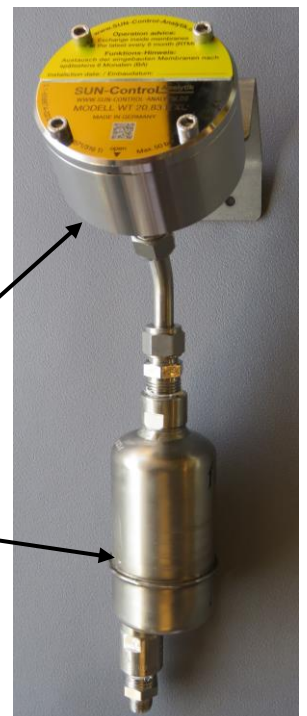

Water-Oil-Trap modell 2083EXL
with automatic condensat drain

Installation examples of SUN-Control-Analytik products



Water-Trap model WT205N

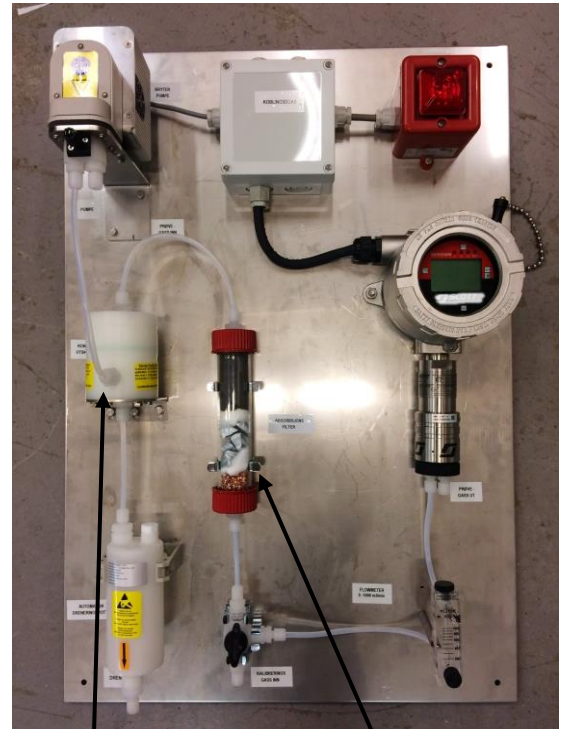

**Water-Acid-Trap
 WT2048KOBU**

**Absorber
 ABS2003**

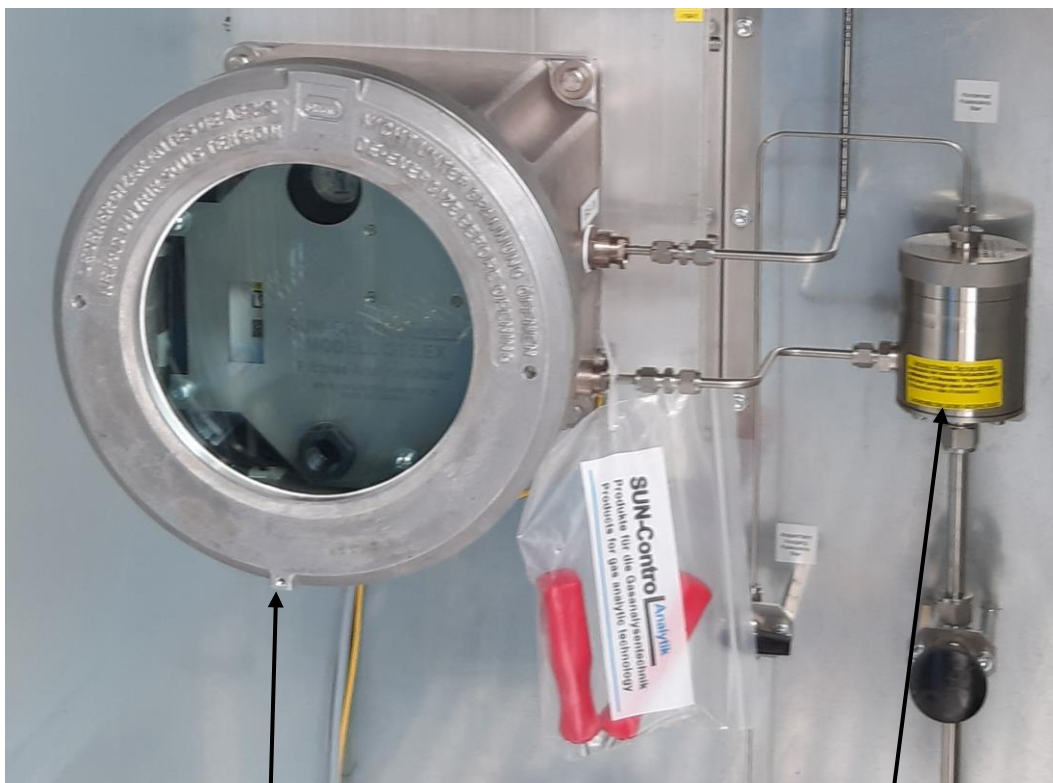

**Process-Analytic-Cooler
 model GT5Ex** 

**Water-Trap
 model WT2048KOBEGT5**

Installation examples of SUN-Control-Analytik products

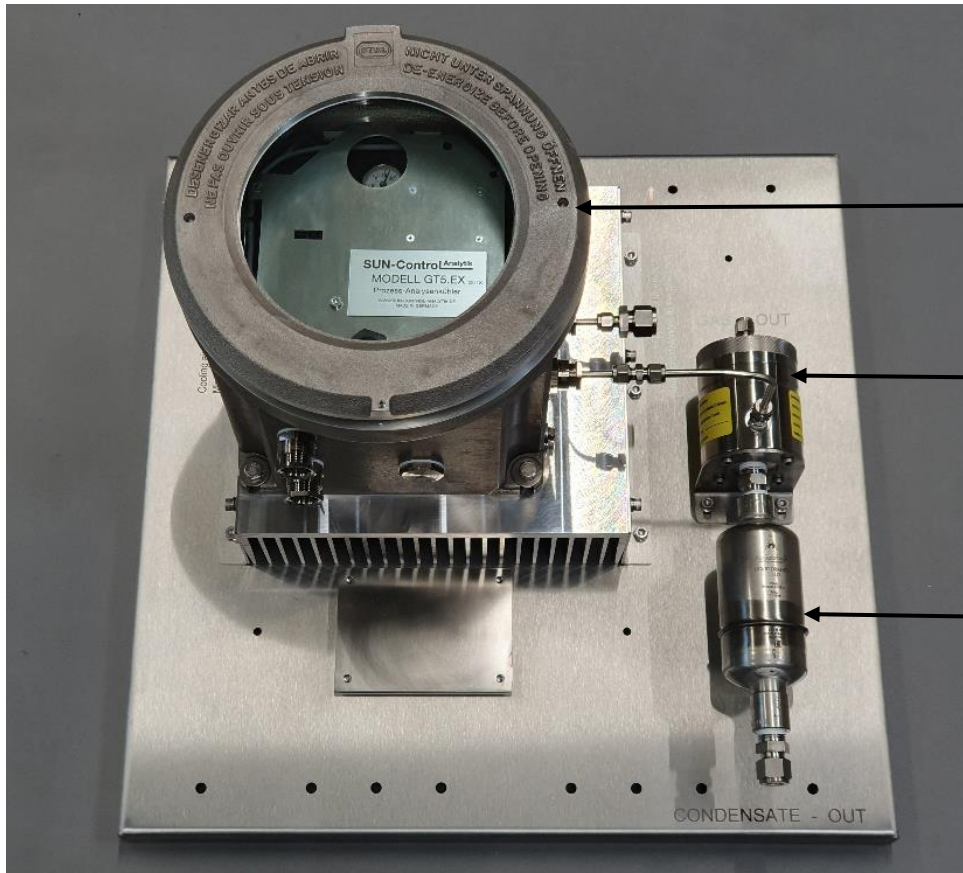

Process-Analytic-Cooler 
 model GT5Ex

Water-Trap
 model WT2048KOBEGT5

automatic condensat drain



Process-Analytic-Cooler
 model
 GT565

Water-Trap
 model
 WT2048KOBEGT5



Process-Analytic-Cooler
 model
 GT565

Water-Trap
 model
 WT2048KOBEGT5

Terms and conditions:

Delivery: Ex works, exclusive of statutory VAT, exclusive of transport, exclusive of insurance

Delivery period: on request

Validity of quotation: up to December 31, 2024

Scope: exclusively with the FRG (GERMANY) and sub-areas of the EU

Bank details:

VR-Bank Handels- und Gewerbebank eG
IBAN: DE75 7206 2152 0004 1644 40
BIC/SWIFT: GENODEF 1 MTG

Tax number: VAT ID: DE 8155 42524

Commercial Register: HRB 29307 Augsburg District Court

Address:

SUN-Control-Analytik GmbH
Pfarrer-Bunk-Straße 21
D-86637 Wertingen (Germany)

Contact:

Telephone: +49 (0)8272-5529
Fax: +49 (0)8272-899856
Mail: sun@sun-c.de
Web: www.sun-c.de

Minimum order value: 120,-- €

Currency: € (EURO)

Producing country: FRG (GERMANY)*

Our General Terms and Conditions are applicable. Subject to change without prior notice